

Industrial Hydraulic Pumps T7/T67/T6

Denison Vane Technology, fixed displacement

aerospace
climate control
electromechanical
filtration
fluid & gas handling
hydraulics
pneumatics
process control
sealing & shielding



ENGINEERING YOUR SUCCESS.

GENERAL		General characteristics	4
		Min. and max. speeds - Pressure ratings	
		Single pumps	5 - 6
		Min. and max. speeds - Pressure ratings	
		Double & triple pumps	7
		Minimum allowable inlet pressure	8 - 9
		Main calculation	10
		Intermittent pressure rating	10
		Description	11
		Start-up instructions & recommendations	
		General	12 - 13
		Shaft & coupling data	13
		Specific point	13
		Fluids	13 - 14
		Formulas	14
		General characteristics	15 - 16
		Notes	17
SINGLE	T7AS	Ordering code and technical data	18
		Dimensions and operating characteristics	19
	T7ASW	Ordering code and technical data	20
		Dimensions and operating characteristics	21
	T7B - T7BS	Ordering code and technical data	22
		Dimensions and operating characteristics	23
	T6C	Ordering code and technical data	24
		Dimensions and operating characteristics	25
	T7D - T7DS	Ordering code and technical data	26
		Dimensions and operating characteristics	27
	T7E - T7ES	Ordering code and technical data	28
		Dimensions and operating characteristics	29
DOUBLE	T7BB - T7BBS	Ordering code and technical data	30
		Dimensions and operating characteristics	31
	T6CC	Ordering code and technical data	32
		Dimensions and operating characteristics	33
	T67CB	Ordering code and technical data	34
		Dimensions and operating characteristics	35
	T7DB - T7DBS	Ordering code and technical data	36
		Dimensions and operating characteristics	37
	T67DC	Ordering code and technical data	38
		Dimensions and operating characteristics	39
	T7DD - T7DDS	Ordering code and technical data	40
		Dimensions and operating characteristics	41
	T7EB - T7EBS	Ordering code and technical data	42
		Dimensions and operating characteristics	43

	T67EC	Ordering code and technical data	44
		Dimensions and operating characteristics	45
	T7ED - T7EDS	Ordering code and technical data	46
		Dimensions and operating characteristics	47
	T7EE - T7EES	Ordering code and technical data	48
		Dimensions and operating characteristics	49
TRIPLE	T7DBB - T7DBBS	Ordering code and operating characteristics	50
		Technical data	51
		Dimensions	52
	T7DCB - T7DCBS	Dimensions	52
		Ordering code and operating characteristics	53
		Technical data	54
	T7DCC - T7DCCS	Technical data	55
		Ordering code and operating characteristics	56
		Dimensions	52
	T7DDB - T7DDBS	Ordering code and operating characteristics	57
		Technical data	58
		Dimensions	59
	T67DDCS	Dimensions	60
		Ordering code and operating characteristics	61
		Technical data	62
	T7EDB - T7EDBS	Technical data	63
		Ordering code and operating characteristics	64
		Dimensions	65
	T67EDC - T67EDCS	Dimensions	66
		Ordering code and operating characteristics	67
		Technical data	68
	T7EEC - T7EECS	Technical data	69
		Ordering code and operating characteristics	70
		Dimensions	71
		Porting diagrams for double and triple pumps.....	72
		Porting diagrams for triple pumps	73
		Notes	74
		Warning	75

CHARACTERISTICS

These vane pumps have been specially designed for high/low circuits. The combination of different cartridges in double and triple pumps allows low flow at high pressure (300 bar max.) and high flow at lower pressure. This is a clever way to optimize your circuit design. This pump feature will also allow a very fast pressure cycle change with a very precise flow repeatability.

GREATER FLOW

Size A : 5,8 to 40,0 ml/rev.
 Size B : 5,8 to 50,0 ml/rev.
 Size C : 10,8 to 100,0 ml/rev.
 Size D : 44,0 to 158,0 ml/rev.
 Size E : 132,3 to 268,7 ml/rev.

HIGHER PRESSURE

A : up to 300 bar max.
 B : up to 320 bar max. (300 bar for multiple pump).
 C : up to 275 bar max.
 D : up to 280 bar max. (250 bar for multiple pump).
 E : up to 240 bar max.

WIDE SPEED RANGE

Industrial pumps : Min. : 600 RPM - Max. up to 3600 RPM

BETTER EFFICIENCY

Increases productivity, reduces heating and reduces operation costs.

LOW NOISE LEVELS

Increases operator safety and eases machines acceptances.

MOUNTING FLEXIBILITY

Single pumps : 4 different positions.
 Double pumps : 32 different positions.
 Triple pumps : 128 different positions.

CARTRIDGE DESIGN

Provides for drop-in assemblies. They permit easy conversion and service.
 A, B and D cartridges : bi-directional technology.
 C and E cartridges : uni-directional technology.

WIDE RANGE OF ACCEPTABLE VISCOSITIES

Viscosities from 860 to 10 cSt permit colder starts and hotter running. The balanced design compensates for wear and temperature changes. At high viscosity or cold temperature, the rotor to side plates gap is well lubricated and improves mechanical efficiency.

FIRE RESISTANT FLUIDS AND BIODEGRADABLE FLUIDS

Phosphate esters, organic esters, chlorinated hydrocarbons, water glycols, rapeseed may be pumped at high pressures and with long service life by these pumps.

GENERAL APPLICATIONS INSTRUCTIONS

1. Check speed range, pressure, temperature, fluid quality, fluid viscosity and pump rotation.
2. Check inlet conditions of the pump, if it can accept the application requirements.
3. Check the type of shaft : if it will support the operating torque.
4. Check the coupling must be chosen to minimize pump shaft load (weight, misalignment).
5. Filtration : must be adequate for the lowest contamination level.
6. Check the environment of the pump : as to avoid noise reflection, pollution and shocks.

Model of pump	Series	Theoretical Displacement Vi ml/rev.	Minimum Speed RPM	Maximum Speed ³⁾		Maximum Pressure					
				HF-0, HF-1 HF-2	HF-3, HF-4 HF-5	HF-0, HF-2		HF-1, HF-4, HF-5		HF-3	
				RPM	RPM	Int. bar	Cont. bar	Int. bar	Cont. bar	Int. bar	Cont. bar
T7AS ²⁾	B06	5,8	600	3600	1800	300	275	240	210	175	140
	B10	9,8									
	B11	11,0									
	B13	12,8									
	B17	17,2									
	B20	19,8									
	B22	22,5									
B25	24,9	3000	275	240							
T7ASW ²⁾	B26	26,0	600	3600	1800	300	275	240	210	175	140
	B28	28,0									
	B30	30,0									
	B32	31,8									
	B34	34,0									
	B36	36,0									
	B40	40,0									
T7B T7BS	B02	5,8	600	3600	1800	320 ¹⁾	290	240	210	175	140
	B03	9,8									
	B04	12,8									
	B05	15,9									
	B06	19,8									
	B07	22,5									
	B08	24,9									
	B09	28,0									
	B10	31,8									
	B11	35,0									
	B12	41,0									
	B14	45,0									
	B15	50,0									
T6C	003	10,8	600	2800	1800	275	240	210	175	175	140
	005	17,2									
	006	21,3									
	008	26,4									
	010	34,1									
	012	37,1									
	014	46,0									
	017	58,3									
	020	63,8									
	022	70,3									
	025	79,3									
	028	88,8									
	031	100,0									

HF-0, HF-2 = Antiwear Petroleum Base - HF-1 = Non Antiwear Petroleum Base - HF-3 = Water in oil Invert Emulsions
 HF-4 = Water Glycols Solutions - HF-5 = Synthetic Fluids

¹⁾ Please consult Parker for application over 300 bar.

²⁾ Please be careful as these cartridge designation are now in ml/rev. (example : B22 = 22,5 ml/rev.)

³⁾ Please be sure that the inlet velocity is under 1,9 m/sec. (see page 12, start-up & check-up).

For further information, or if the performance characteristics outlined here above do not meet your particular requirements, please consult your local Parker office.

Model of pump	Series	Theoretical Displacement Vi ml/rev.	Minimum Speed RPM	Maximum Speed ³⁾		Maximum Pressure					
				HF-0, HF-1 HF-2	HF-3, HF-4 HF-5	HF-0, HF-2		HF-1, HF-4, HF-5		HF-3	
				RPM	RPM	Int. bar	Cont. bar	Int. bar	Cont. bar	Int. bar	Cont. bar
T7D T7DS	B14	44,0	600	3000	1800	300	250	240	210	175	140
	B17	55,0									
	B20	66,0									
	B22	70,3									
	B24	81,1									
	B28	90,0									
	B31	99,2									
	B35	113,4									
	B38	120,6									
	B42	137,5									
	045 ¹⁾	145,7									
050 ¹⁾	158,0										
T7E ²⁾ T7ES	042	132,3	600	2200	1800	240	210	210	175	175	140
	045	142,4									
	050	158,5									
	052	164,8									
	054	171,0									
	057	183,3									
	062	196,7									
	066	213,3									
	072	227,1									
	085	268,7									

HF-0, HF-2 = Antiwear Petroleum Base

HF-1 = Non Antiwear Petroleum Base

HF-3 = Water in oil Invert Emulsions

HF-4 = Water Glycols Solutions

HF-5 = Synthetic Fluids

¹⁾ Ten vane technology.

²⁾ For T7E, below 10 bar, please contact Parker.

³⁾ Please be sure that the inlet velocity is under 1,9 m/sec. (see page 12, start-up & check-up).

For further information, or if the performance characteristics outlined here above do not meet your particular requirements, please consult your local Parker office.

Model of pump	Series	Theoretical Displacement Vi ml/rev.	Minimum Speed RPM	Maximum Speed ³⁾			Maximum Pressure					
				HF-0, HF-1	HF-3, HF-4	HF-5	HF-0, HF-2		HF-1, HF-4, HF-5		HF-3	
				HF-2	HF-5		Int.	Cont.	Int.	Cont.	Int.	Cont.
				RPM	RPM	RPM	bar	bar	bar	bar	bar	bar
T7BB/S T67CB T7DB/S T7EB/S T7DBB/S T7DCB/S T7DDB/S T7EDB/S	B02	5,8	600	2200 ²⁾	1800	T7BB T7BBS 320 ¹⁾	T7BB T7BBS 290	240	210	175	140	
	B03	9,8										
	B04	12,8										
	B05	15,9										
	B06	19,8										
	B07	22,5										
	B08	24,9										
	B09	28,0										
	B10	31,8										
	B11	35,0										
	B12	41,0										Other pumps 300
	B14	45,0				280	240					
	B15	50,0										
T6CC T67CB T67DC T67EC T7DCB/S T7DCC/S T67DDCS T67EDC/S T7EEC/S	003	10,8	600	2200 ²⁾	1800	275	240	210	175	175	140	
	005	17,2										
	006	21,3										
	008	26,4										
	010	34,1										
	012	37,1										
	014	46,0										
	017	58,3										
	020	63,8										
	022	70,3										
	025	79,3				210	160	160				
028	88,8											
031	100,0											
T7DB/S T67DC T7DD/S T7EDS T7DBB/S T7DCB/S T7DCC/S T7DDB/S T67DDCS T7EDB/S T67EDC/S	B14	44,0	600	2200 ²⁾	1800	300	250	240	210	175	140	
	B17	55,0										
	B20	66,0										
	B22	70,3										
	B24	81,1										
	B28	90,0										
	B31	99,2										
	B35	113,4				280						
	B38	120,6										
	B42	137,5				260	230					
	045 ¹⁾	145,7				240	210	210	175			
	050 ¹⁾	158,0				210	160	210	160			
	T7EB/S T67EC T7EDS T7EE/S T7EEC/S T67EDB/S T67EDC/S	042				132,3	600	2200 ²⁾	1800	240	210	210
045		142,4										
050		158,5										
052		164,8										
054		171,0										
057		183,3										
062		196,7										
066		213,3										
072		227,1										
085	268,7	90	75	75	75	75	75					

HF-0, HF-2 = Antiwear Petroleum Base HF-1 = Non Antiwear Petroleum Base HF-3 = Water in oil Invert Emulsions
 HF-4 = Water Glycols Solutions HF-5 = Synthetic Fluids

¹⁾ Please consult Parker for application over 300 bar.

²⁾ Please consult Parker with higher speeds.

³⁾ Please be sure that the inlet velocity is under 1,9 m/sec. (see page 12, start-up & check-up).

For further information or if the performance characteristics outlined above do not meet your particular requirements, please consult your local Parker office.



Minimum allowable inlet pressure (bar absolute) T7/T67/T6C Industrial, Denison Vane Pumps

Minimum allowable inlet pressure (bar absolute)

Cartridge		Speed RPM										Series						
Size	Series	1200	1500	1800	2100	2200	2300	2500	2800	3000	3600							
AS	B06	0,80	0,80	0,80	0,80	0,80	0,80	0,80	0,80	0,80	0,80	0,80	0,80	B06				
	B10													B10				
	B11													B11				
	B13												B13					
	B17												0,88	B17				
	B20												0,94	B20				
	B22												1,00	B22				
	B25											0,85	B25					
ASW	B26	0,80	0,80	0,80	0,80	0,80	0,80	0,80	0,80	0,80	0,80	0,80	0,80	B26				
	B28													B28				
	B30													B30				
	B32												B32					
	B34												0,88	B34				
	B36												0,94	B36				
	B40											1,00	B40					
B	B02	0,80	0,80	0,80	0,80	0,80	0,80	0,80	0,80	0,80	0,80	0,80	0,80	B02				
	B03													B03				
	B04													B04				
	B05												B05					
	B06												0,82	0,98	B06			
	B07											0,85	1,05	B07				
	B08											0,85	1,05	B08				
	B09											0,85	1,05	B09				
	B10											0,90	1,15	B10				
	B11											0,90	1,15	B11				
	B12											0,90	1,15	B12				
	B14											0,84	0,99	1,13	B14			
	B15											0,84	0,99	1,13	B15			
	C											003	0,80	0,80	0,80	0,80	0,80	0,80
005		005																
006		006																
008		008																
010		010																
012		0,85	0,92	012														
014		0,85	0,92	014														
017		0,85	0,95	1,03	017													
020		0,90	0,90	1,03	020													
022		0,85	0,90	0,98	1,05	022												
025		0,90	0,95	0,95	1,05	025												
028		0,90	0,98	0,98	1,08	028												
031		0,85	0,90	1,11	1,11	031												

Inlet pressure is measured at inlet flange with petroleum base fluids at viscosity between 10 and 65 cSt. The difference between inlet pressure at the pump flange and atmospheric pressure must not exceed 0,2 bar to prevent aeration.

Multiply absolute pressure by 1,25 for HF-3, HF-4 fluids.

by 1,35 for HF-5 fluid.

by 1,10 for ester or rapeseed base.

For double and triple pumps, prefer the cartridge requiring the highest absolute pressure.

Minimum allowable inlet pressure

T7/T67/T6C Industrial, Denison Vane Pumps

Cartridge		Speed RPM										Series			
Size	Series	1200	1500	1800	2100	2200	2300	2500	2800	3000	3600				
D	B14	0,80	0,80	0,80	0,80	0,80	0,80	0,80	0,80	0,80		B14			
	B17											B17			
	B20								0,82	0,86		B20			
	B22								0,83	0,88		B22			
	B24								0,86	0,95		B24			
	B28								0,88	1,00		B28			
	B31								0,90	1,05		B31			
	B35								0,84	0,97		B35			
	B38								0,86	1,01		B38			
	B42								0,90			B42			
	045								0,85	0,98		1,05	045		
	050									1,02		1,09	050		
E	042	0,80	0,80	0,80	0,90	1,00						042			
	045											045			
	050											050			
	052											052			
	054											054			
	057			0,85	0,95							057			
	062											062			
	066			0,85	0,85							0,95	1,00	1,09	066
	072											0,85	1,05	072	
	085											0,90	0,90	1,00	085

Inlet pressure is measured at inlet flange with petroleum base fluids at viscosity between 10 and 65 cSt. The difference between inlet pressure at the pump flange and atmospheric pressure must not exceed 0,2 bar to prevent aeration.

Multiply absolute pressure by 1,25 for HF-3, HF-4 fluids.

by 1,35 for HF-5 fluid.

by 1,10 for ester or rapeseed base.

For double and triple pumps, prefer the cartridge requiring the highest absolute pressure.

MAIN CALCULATION

To resolve

Volumetric displ. .. V_i [ml/rev.]

Available flow..... Q_{eff} [l/min]

Input power..... P_{eff} [kW]

Performances required

Requested flow Q [l/min] 42

Speed..... n [RPM] 1500

Pressure..... p [bar] 250

Routine :

Example :

1. First calculation $V_i = \frac{1000 Q}{n}$

$V_i = \frac{1000 \times 42}{1500} = 28 \text{ ml/rev.}$

2. Choice V_i of pump immediately greater (see tabulation)

T7B B10, $V_i = 31,8 \text{ cm}^3/\text{rev.}$

3. Theoretical flow of this pump

$Q_{theo} = \frac{V_i \times n}{1000}$

$Q_{theo} = \frac{31,8 \times 1500}{1000} = 47,7 \text{ l/min}$

4. Find q_{vs} leakage function of pressure

$q_{vs} = f(p)$ on curve at 10 or 24 cSt

T7B (page 22) : $q_{vs} = 3 \text{ l/min}$ at 250 bar, 24 cSt

5. Available flow $Q_{eff} = Q_{theo} - q_{vs}$

$Q_{eff} = 47,7 - 3 = 44,7 \text{ l/min}$

6. Theoretical input power

$P_{theo} = \frac{Q_{theo} \times P}{600}$

$P_{theo} = \frac{47,7 \times 250}{600} = 19,9 \text{ kW}$

7. Find P_s hydrodynamic power loss on curve

T7B (page 22) : P_s at 1500 RPM, 250 bar = 1 kW

8. Calculation of necessary input power

$P_{eff} = P_{theo} + P_s$

$P = 19,9 + 1 = 20,9 \text{ kW}$

9. Results

$V_i = 31,8 \text{ ml/rev.}$	T7B B10
$Q_{eff} = 47,7 \text{ l/min}$	
$P_{eff} = 20,9 \text{ kW}$	

These calculation steps must be followed for each application.

INTERMITTENT PRESSURE RATING

T7 and T67 units may be operated intermittently at pressures higher than the recommended continuous rating when the time weighted average of pressure is less than or equal to the continuous duty pressure rating. This intermittent pressure rating calculation is only valid when the other parameters : speed, fluid, viscosity and contamination level are respected.

For total cycle time longer than 15 minutes, please consult your Parker representative.

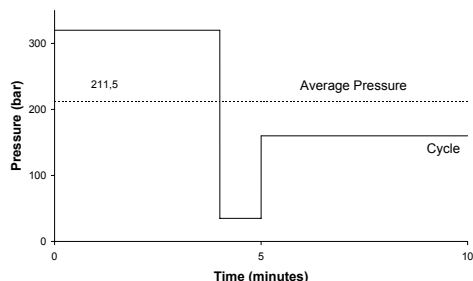

Example : T7B - B10

Duty cycle 4 min. at 320 bar

..... 1 min. at 35 bar

..... 5 min. at 160 bar

$\frac{(4 \times 320) + (1 \times 35) + (5 \times 160)}{10} = 211,5 \text{ bar}$

211,5 bar is lower than 290 bar allowed as continuous pressure for T7B - B10 with HF-0 fluid.

Description

Hydraulic Pumps

T7/T67/T6C Industrial, Denison Vane Pumps

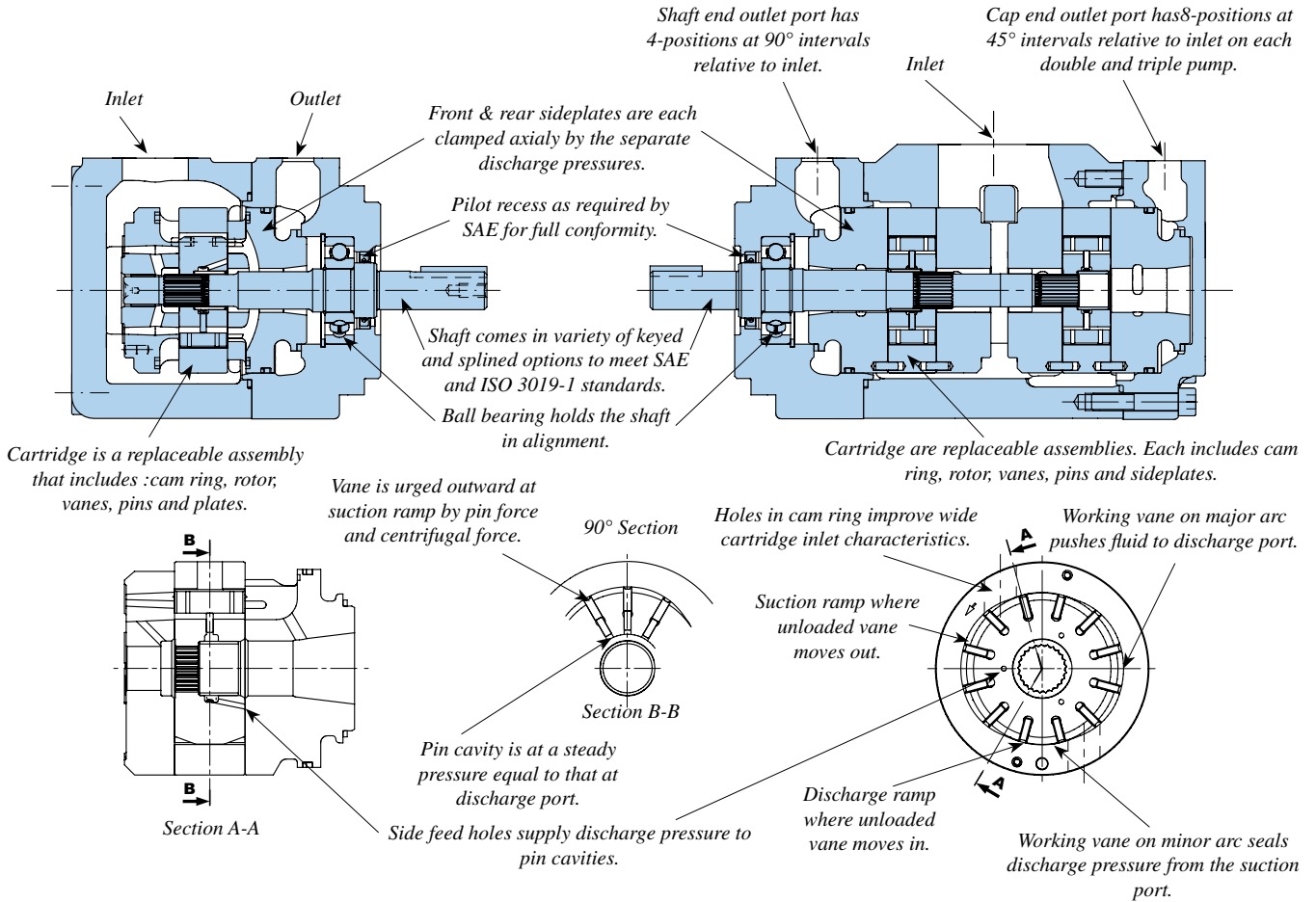

APPLICATION ADVANTAGES

- The high pressure capability up to 320 bar, in the small envelope, reduces installation costs and provides extended life at reduced pressure.
- The high volumetric efficiency, reduces heat generation, and allows speeds down to 600 RPM at full pressure.
- The high mechanical efficiency, typically better than 94%, reduces energy consumption.
- The wide speed range (600 RPM at 3600 RPM), combined with large size cartridge displacements will optimize operation for the lowest noise level in the smallest envelope.
- The low speed (600 RPM), low pressure, high viscosity (860 cSt) allows application in cold environment with a minimum energy consumption and without risk of seizure.
- The low ripple pressure (± 2 bar) reduces piping noise and increases lifetime of the other components in the circuit.
- The high resistance to particle contamination, thanks to the double lip technology increasing the pump lifetime.
- The large variety of options (cam displacement, shaft, porting) allows customized installation.
- Noise : Specially designed to optimize the low noise level characteristics.
- Cartridge concept : drops maintenance costs.

Start-up instructions & recommendations T7/T67/T6C Industrial, Denison Vane Pumps

GENERAL :

All Parker vane pumps are individually tested to provide the best quality & reliability. Modifications, conversions & repairs can only be done by authorized dealers or OEM to avoid invalidation of the guarantee.

The pumps are to be used in the design limits indicated in all the sales bulletins. Please contact Parker when trespassing the catalogue limits.

Do not modify or work on the pump under pressure or when the electric motor (or any drive) is on.

Qualified personnel is required to assemble and set-up hydraulic devices.

Always conform yourself to the valid regulations (safety, electrical, environment...).

The following instructions are important to follow to obtain a good service life time from the unit.

ROTATION & PORTS INDICATION

The rotation and ports orientation are viewed from the shaft end.

CW stands for clockwise = right-hand rotation.

CCW stands for counter-clockwise = left-hand rotation.

START-UP CHECK-UP

Check that the assembly of the power unit is correct :

The distance between the suction pipe & the return lines in the tank should be at its maximum.

A bevel on both suction & return lines is recommended to increase the surface and so lower the velocity. We suggest a 45° minimum angle.

Velocities : inlet $0,5 < x < 1,9$ m/s (1,64 < x < 6,23 ft per sec.)
 : return $x < 6$ m/s (x < 19,7 ft per sec.)

: Always insure that all return and suction lines are under the oil level to avoid forming aeration or vortex effect. This should be done under the most critical situation (all cylinders extended for example). Straight and short pipes are the best.

$$V = \frac{Q \text{ (Lpm)}}{6 \times \pi \times r^2 \text{ (cm)}} = \text{m/s} \quad V = \frac{Q \text{ (GPM)}}{3.12 \times \pi \times r^2 \text{ (in)}} = \text{ft/s}$$

The size of the air filter should be 3 times greater than the max. instant return flow (all cylinders in movement for example).

If the pump is in the tank, please choose the NOP option (no paint) and use a short inlet pipe.

Parker does not recommend inlet strainers. If needed, a 100 mesh (149 microns) is the finest mesh recommended.

A coaxial drive is recommended. For any other type of drives, please contact Parker.

Make sure that all protective plugs & covers have been removed.

Check the pump rotation versus the E-motor or engine rotation.

Start-up :

The tank has been filled up with a clean fluid in proper conditions.

We recommend to flush the system with an external pump prior to the start-up.

It is important to bleed the air off the circuit & the pump itself.

The first valve on the circuit should be open to tank.

We recommend the use of air bleed off valves.

It is possible to bleed off the air by creating a leak in the P port of the pump. **Warning : this has to be done in a low pressure mode as it could create a dangerous fluid leak. Make sure that the pressure cannot rise (open center valve to tank, pressure relief valve unloaded ...).**

When oil free of air appears, tighten the connectors to the correct torque.

The pump should prime within a few seconds. If not, please consult our troubleshooting guide (document 1 - EN0721 - *).

If the pump is noisy, please troubleshoot the system.

Never operate the pump at top speed and pressure without checking the completion of pump priming.

SHAFT & COUPLING DATA :

COUPLINGS AND FEMALE SPLINES

- The mating female spline should be free to float and find its own center. If both members are rigidly supported, they must be aligned within 0,15 TIR (0.006" TIR) or less to reduce fretting. The angular alignment of two splines axes must be less than $\pm 0,05$ per 25,4 radius (± 0.002 " per 1" radius).

- The coupling spline must be lubricated with a lithium molydisulfide grease, disulfide of molybdenum or a similar lubricant.

- The coupling must be hardened to a hardness between 29 and 45 HRC.

- The female spline must be made to conform to the Class 1 fit as described in SAE-J498b (1971). This is described as a Flat Root Side Fit.

Parker supplies the T7 series keyed shaft pumps with high strength heat-treated keys. Therefore, when installing or replacing these pumps, the heat-treated keys must be used in order to ensure maximum life in the application. If the key is replaced, it must be a heat-treated key between 27 and 34 R.C. hardness. The corners of the keys must be chamfered by 0,76 mm to 1,02 mm (0.03 to 0.04) at 45° to clear the radii in the key way.

The alignment of keyed shafts must be within tolerances given for splined shafts here above.

These products are primarily designed for coaxial drives which do not impose axial or side loading on the shaft. Contact Parker for specific applications.

KEYED SHAFTS

SHAFT LOADS

SPECIFIC POINTS :

MINIMUM INLET PRESSURE

Please read the charts in the sales leaflets as the minimum requested inlet pressure varies versus the displacement and the speed.

Never go under 0,8 bar Absolute (-0,2 bar relative)

11.6 PSI Absolute (-2.9 PSI G).

MAXIMUM INLET PRESSURE

It is recommended to always have at least 1,5 bar (22 PSI) differential between inlet and outlet.

Standard shaft seals are limited to 0,7 bar (10 PSI G) but some allow 7 bar (100 PSI G). Please contact Parker for more information.

MINIMUM OUTLET PRESSURE

It is recommended to always have at least 1,5 bar (22 PSI) differential between inlet and outlet.

VERTICAL MOUNT

When assembled vertically, always be careful to prevent any air from being trapped in the pump (behind the shaft seal for example).

FLUIDS :

DENISON CLASSIFICATION

Type of fluids : For each type of fluids, Parker vane pumps will have different pressures, speeds & temperature limits. Please refer to the sales leaflets.

HF-0 = Anti-wear petroleum base.

HF-1 = Non anti-wear petroleum base.

HF-2 = Anti-wear petroleum base.

HF-3 = Water-in-oil invert emulsions.

HF-4 = Water glycol solutions.

HF-5 = Synthetic fluids.

FILTRATION RECOMMENDATIONS

NAS 1638 class 8 or better.
 ISO 19 / 17 / 14 or better.
 Inlet strainer : Parker does not recommend inlet strainers.
 If requested, a 100 mesh (149 microns) is the finest mesh recommended.

RECOMMENDED FLUIDS

Petroleum based antiwear R & O fluids.
 These fluids are the recommended fluids for pumps & motors. Maximum catalogue (UK version) ratings and performance datas are based on operation with these fluids. These fluids are covered by Denison HF-0 and HF-2 specifications.

ACCEPTABLE ALTERNATE FLUIDS

The use of fluids other than petroleum based antiwear R & O fluids requires that the maximum ratings of the pumps will be reduced. In some cases the minimum replenishment pressures must be increased. Consult specific sections for more details.

VISCOSITY

	Industrial
Max. (cold start, low speed & pressure)	860 cSt - 3900 SUS
Max. (full speed & pressure)	108 cSt - 500 SUS
Optimum (max. life)	30 cSt - 140 SUS
Min. (full speed & pressure for HF-1, HF-3, HF-4 & HF-5 fluids)	18 cSt - 90 SUS
Min. (full speed & pressure for HF-0 & HF-2 fluids)	10 cSt - 60 SUS

VISCOSITY INDEX

90 min. Higher values extend the range of operating temperatures.

TEMPERATURES

The usual limiting factor of temperature (low or high) comes from the obtained viscosity. The seals are sometimes the limit : standard seals range from -30° C to 90° C (-9.4° F to 194° F).

Maximum fluid temperature (θ)	° C	° F
HF-0, HF-1, HF-2	+ 100	+ 212
HF-3, HF-4	+ 50	+ 122
HF-5	+ 70	+ 158
Biodegradable fluids (esters & rapeseed base)	+ 65	+ 149
Minimum fluid temperature (θ)	° C	° F
(also depend on max. viscosity)		
HF-0, HF-1, HF-2, HF-5	- 18	- 0.4
HF-3, HF-4	+ 10	+ 50
Biodegradable fluids (esters & rapeseed base)	- 18	- 0.4

Over or under these values, please contact Parker.

WATER CONTAMINATION IN THE FLUID

Maximum acceptable content of water :
 • 0,10 % for mineral base fluids.
 • 0,05 % for synthetic fluids, crankcase oils, biodegradable fluids.
 If the amount of water is higher, then it must be drained off the circuit.

FLUID POWER FORMULAS

Pump input torque	N.m	$\frac{\text{pressure (bar)} \times \text{displacement cm}^3/\text{rev}}{20 \pi \times \text{mech. eff.}}$
Pump input power	kW	$\frac{\text{rpm} \times (\text{cm}^3/\text{rev}) \times \text{pressure (bar)}}{600000 \times \text{overall eff.}}$
Pump output flow	Lpm	$\frac{\text{rpm} \times (\text{cm}^3/\text{rev}) \times \text{volumetric eff.}}{1000}$
Fluid motor speed	rpm	$\frac{1000 \times \text{flow rate (Lpm)} \times \text{volumetric eff.}}{\text{displacement (cm}^3/\text{rev.)}}$
Fluid motor torque	N.m	$\frac{\text{pressure (bar)} \times \text{displacement (cm}^3/\text{rev)} \times \text{mech. eff.}}{20 \pi}$
Fluid motor power	kW	$\frac{\text{rpm} \times (\text{cm}^3/\text{rev}) \times (\text{bar}) \times \text{overall eff.}}{600000}$

	Mounting standard	Weight without connector and bracket - kg	Moment of inertia Kg ^m ² x 10 ⁻⁴	SAE 4 bolts - J518 - ISO/DIS6162-1		
				Suction	Pressure	
				S	P1	
T7AS	SAE J744 SAE A	9,5	2,6	1"-SAE 4 bolts J518-ISO/DIS 6162-1	3/4"-SAE 4 bolts J518-ISO/DIS 6162-1	
				SAE 16-SAE threads 1.5/16"-12 UNF-2B	SAE 12-SAE threads 1.1/16"-12 UNF-2B	
				NPTF threads 1.1/4" NPTF	NPTF threads 3/4" NPTF	
				1" BSP	3/4" BSP	
T7ASW	SAE J744 SAE A	11,3	3,2	1.1/4"-SAE 4 bolts J518-ISO/DIS 6162-1	3/4"-SAE 4 bolts J518-ISO/DIS 6162-1	
				SAE 20-SAE threads 1.5/8"-12 UNF-2B	SAE 12-SAE threads 1.1/16"-12 UNF-2B	
				NPTF threads 1.1/4" NPTF	SAE 12-SAE threads 1.1/16"-12 UNF-2B	
				1.1/4" BSP	3/4" BSP	
T7B	ISO 3019-2 100 A2 HW	23,0	3,2	1.1/2"	1" or 3/4"	
T7BS	SAE J744 SAE B					
T6C	SAE J744 SAE B	15,7	7,5	1.1/2"	1"	
T7D	ISO 3019-2 125 A2 HW	26,0	19,6	2"	1.1/4"	
T7DS	SAE J744 SAE C					
T7E	ISO 3019-2 125 A2 HW	43,3	62,5	3"	1.1/2"	
T7ES	SAE J744 SAE C					
				S	P1	P2
T7BB	ISO 3019-2 100 A2 HW	32,6	6,7	2.1/2"	1" or 3/4"	3/4"
T7BBS	SAE J744 SAE B					
T6CC	SAE J744 SAE B	26,0	16,9	2.1/2" or 3"	1"	1" or 3/4"
T67CB	SAE J744 SAE B	26,0	11,4	2.1/2"	1"	3/4"
T7DB	ISO 3019-2 125 A2 HW	38,6	22,7	3"	1.1/4"	1" or 3/4"
T7DBS	SAE J744 SAE C					
T67DC	SAE J744 SAE C	38,6	26,3	3"	1.1/4"	1" or 3/4"
T7DD	ISO 3019-2 125 A2 HW 125 B4HW	56,0	36,3	4"	1.1/4"	1.1/4"
T7DDS	SAE J744 SAE C					
T7EB	ISO 3019-2 125 A2 HW	55,0	65,9	3.1/2"	1.1/2"	3/4"
T7EBS	SAE J744 SAE C					
T67EC	SAE J744 SAE C	55,0	70,8	3.1/2"	1.1/2"	1"
T7ED	ISO 3019-2 125 A2 HW	66,0	79,7	4"	1.1/2"	1.1/4"
T7EDS	SAE J744 SAE C					
T7EE	ISO 3019-2 250 B4 HW	95,0	97,4	4"	1.1/2"	1.1/2"
T7EES	SAE J744 SAE E					

General characteristics

	Mounting standard	Weight without connector and bracket - kg	Moment of inertia Kgm ² x 10 ⁻⁴	SAE 4 bolts - J518 - ISO/DIS6162-1			
				Suction	Pressure		
				S	P1	P2	P3
T7DBB	ISO/3019-2 125 A2 HW 125 B4 HW	61,0	26,1	4"	1.1/4"	1"	1" or 3/4"
T7DBBS	SAE J744 SAE C						
T7DCB	ISO/3019-2 125 A2 HW 125 B4 HW		29,7				
T7DCBS	SAE J744 SAE C						
T7DCC	ISO/3019-2 125 A2 HW 125 B4 HW		33,3				
T7DCCS	SAE J744 SAE C						
T7ddb	ISO/3019-2 125 A2 HW 125 B4 HW	66,0	39,5	4"	1.1/4"	1.1/4"	1" or 3/4"
T7ddbS	SAE J744 SAE C						
T67DDCS	SAE J744 SAE C	66,0	43,1	4"	1.1/4"	1.1/4"	1" or 3/4"
T7EDB	ISO 3019-2 250 B4 HW	102,0	76,6	4"	1.1/2"	1.1/4"	1" or 3/4"
T7EDBS	SAE J744 SAE E						
T67EDC	ISO 3019-2 250 B4 HW	102,0	80,2	4"	1.1/2"	1.1/4"	1" or 3/4"
T67EDCS	SAE J744 SAE E						
T7EEC	ISO/3019-2 250 B4 HW	114,8	99,1	4"	1.1/2"	1.1/2"	1" or 3/4"
T7EECS	SAE J744 SAE E						

Model No.

T7AS - B17 - 1 R 00 - A 1 - 00 - ..

T7AS series - SAE A 2 bolts
 J744 mounting flange

Displacement *
 Volumetric displacement (ml/rev.)
 B06 = 5,8
 B10 = 9,8
 B11 = 11,0
 B13 = 12,8
 B17 = 17,2
 B20 = 19,8
 B22 = 22,5
 B25 = 24,9

Type of shaft T7AS
 1 = keyed (non SAE) Ø 19,05
 3 = splined 16/32 (SAE B) 13 teeth
 4 = splined 16/32 (SAE A) 9 teeth

Direction of rotation (shaft end view)
 R = Clockwise
 L = Counter-clockwise

Modifications

Mounting w/connection variables

00 = 4 bolts SAE flanges (J518) UNC thread
 S = 1" SAE
 P = 3/4" SAE
 02 = SAE thread
 S = 1.5/16" (SAE 16)
 P = 1.1/16" (SAE 12)
 03 = NPTF thread
 S = 1.1/4" NPTF
 P = 3/4" NPTF
 04 = BSP threads
 S = 1" BSP
 P = 3/4" BSP

Seal class

1 = S1 BUNA N - 0,7 bar max. (for mineral oil)
 5 = S5 VITON® - 0,7 bar max. (for mineral oil and fire resistant fluids)

Design letter

Porting combination
 00 = standard

P = Pressure
 S = Suction

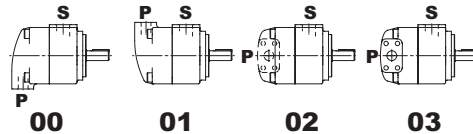

INTERNAL LEAKAGE (TYPICAL)

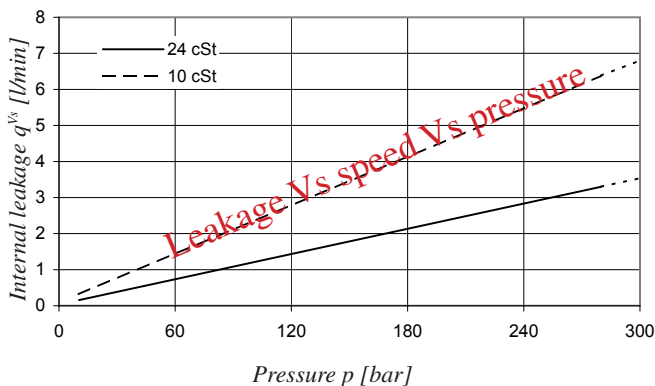

Do not operate pump more than 5 seconds at any speed or viscosity if internal leakage is higher than 50% of theoretical flow.

NOISE LEVEL (TYPICAL) - T7AS - B20

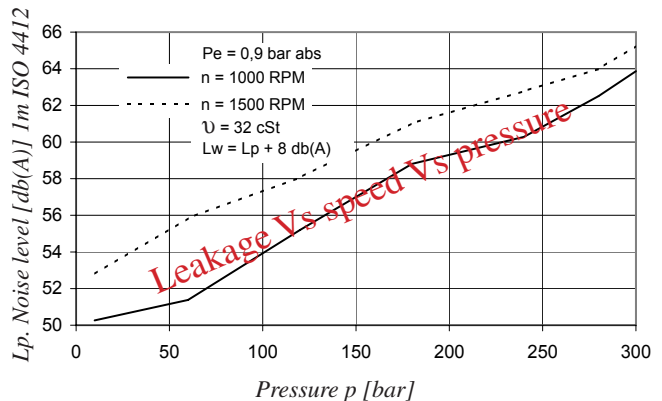

POWER LOSS HYDROMECHANICAL (TYPICAL)

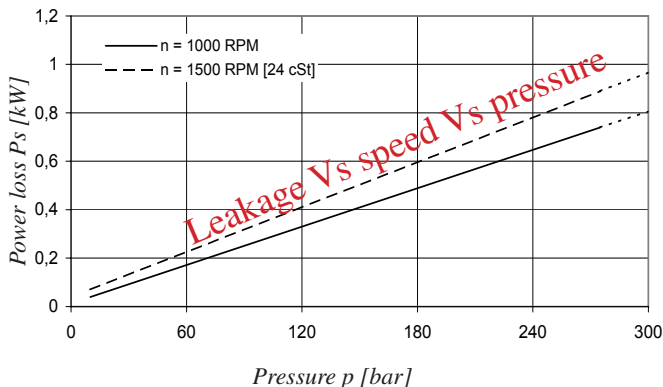

* Cartridge designation is now in ml/rev. (example : B22 = 22,5 ml/rev.)

PERMISSIBLE RADIAL LOAD

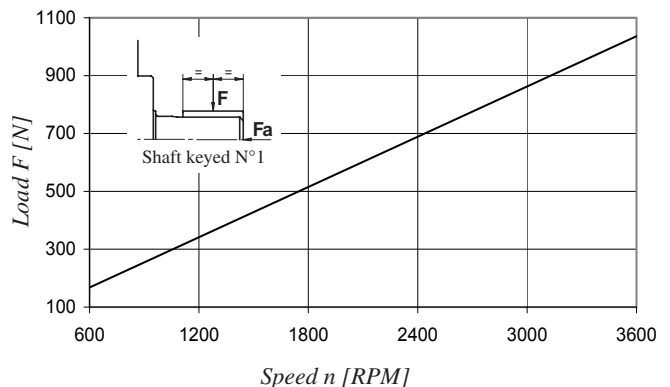

Maximum permissible axial load $F_a = 600\text{ N}$

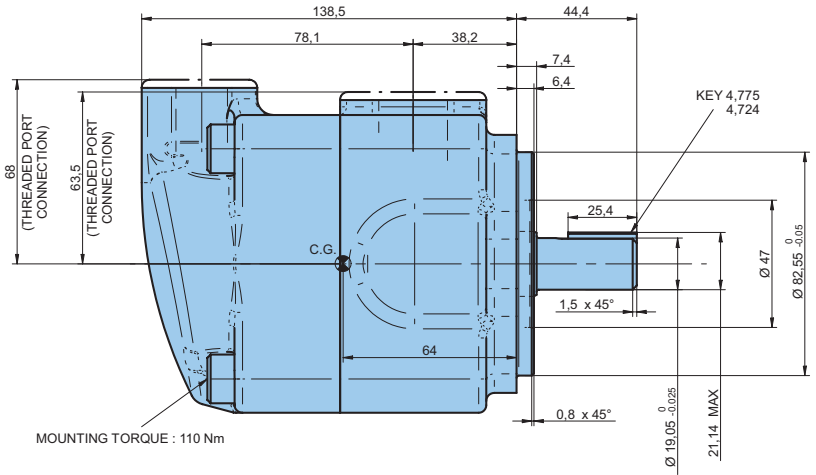
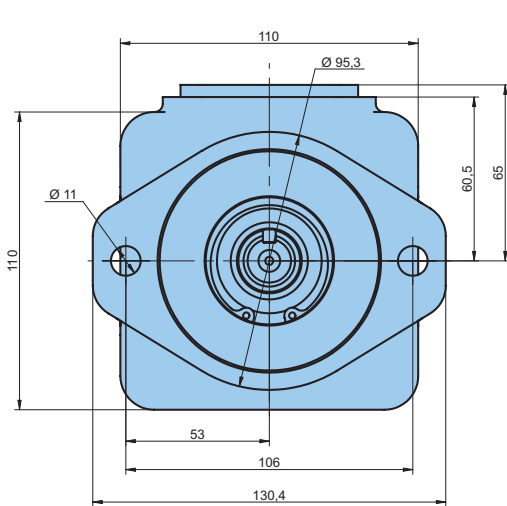

SHAFT CODE 1
Keyed (non SAE)

Option : built in valve

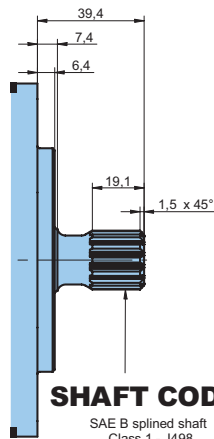
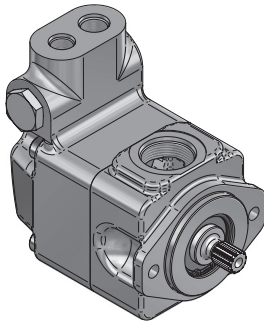

SHAFT CODE 3

SAE B splined shaft
Class 1 - J498
16/32 d.p. - 13 teeth
30° pressure angle
flat root side fit

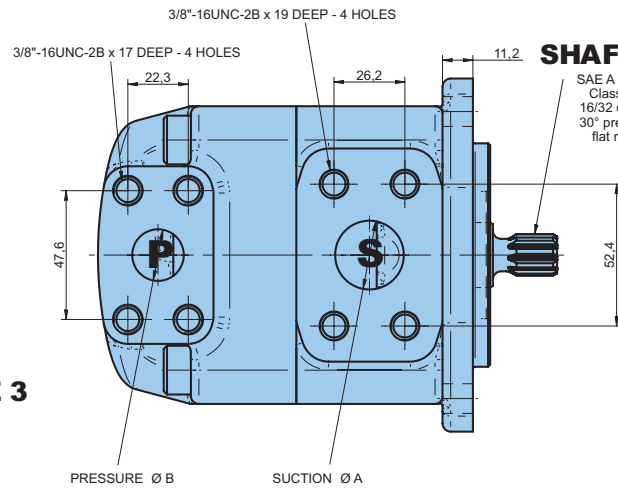

SHAFT CODE 4

SAE A splined shaft
Class 1 - J498
16/32 d.p. - 9 teeth
30° pressure angle
flat root side fit

Code	00	02	03	04
A	Ø 25,40	SAE # 16 1.5/16" - 12 UNF - 2B	1.1/14" NPTF	1" BSP
B	Ø 19,05	SAE # 12 1.1/16" - 12 UNF - 2B	3/4" NPTF	3/4" BSP

Shaft torque limits [ml/rev. x bar]	
Shaft	Vi x p max.
1	8720
3	8720
4	6550



If inlet velocity > 1,9 m/s, please contact Parker.

OPERATING CHARACTERISTICS - TYPICAL [24 cSt]

Pressure port	Series	Vi Volumetric displacement	Flow q_{vc} [l/min] & n = 1500 RPM			Input power P [kW] & n = 1500 RPM		
			p = 0 bar	p = 140 bar	p = 300 bar	p = 7 bar	p = 140 bar	p = 300 bar
T7AS	B06	5,8 ml/rev	8,7	7,0	5,2	0,2	2,7	6,0
	B10	9,8 ml/rev	14,7	13,0	11,2	0,3	4,1	9,0
	B11	11,0 ml/rev	16,5	14,8	13,0	0,4	4,5	9,9
	B13	12,8 ml/rev	19,2	17,5	15,7	0,4	5,1	11,3
	B17	17,2 ml/rev	25,8	24,1	22,3	0,5	6,6	14,6
	B20	19,8 ml/rev	29,7	28,0	26,2	0,6	7,6	16,5
	B22	22,5 ml/rev	33,8	32,1	30,2	0,6	8,5	18,6
B25	24,9 ml/rev	37,4	35,7	33,8 ¹⁾	0,7	9,3	20,4 ¹⁾	

¹⁾ B25 = 275 bar max. int.

Model No.

T7ASW - B32 - 1 R 00 - A 1 - 00 - ..

T7ASW series - SAE A 2 bolts
 J744 mounting flange

Displacement *
 Volumetric displacement (ml/rev.)
 B26 = 26,0
 B28 = 28,0
 B30 = 30,0
 B32 = 31,8
 B34 = 34,0
 B36 = 36,0
 B40 = 40,0

Type of shaft T7ASW
 1 = keyed (non SAE) Ø 19,05
 3 = splined 16/32 (SAE B) 13 teeth
 4 = splined 16/32 (non SAE) 11 teeth

Direction of rotation (shaft end view)
 R = Clockwise
 L = Counter-clockwise

Modifications

Mounting w/connection variables

00 = 4 bolts SAE flanges (J518) UNC threads
 S = 1.1/4" SAE
 P = 3/4" SAE
 02 = SAE thread
 S = 1.5/8" (SAE 20)
 P = 1.1/16" (SAE 12)
 03 = NPTF & SAE threads
 S = 1.1/4" NPTF
 P = 1.1/16" (SAE 12)
 04 = BSP threads
 S = 1.1/4" BSP
 P = 3/4" BSP

Seal class

1 = S1 BUNA N - 0,7 bar max. (for mineral oil)

Design letter

Porting combination

00 = standard

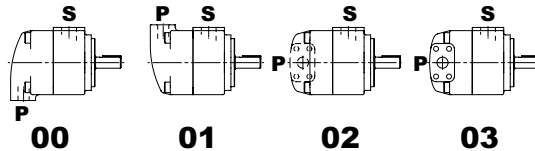

P = Pressure
 S = Suction

INTERNAL LEAKAGE (TYPICAL)

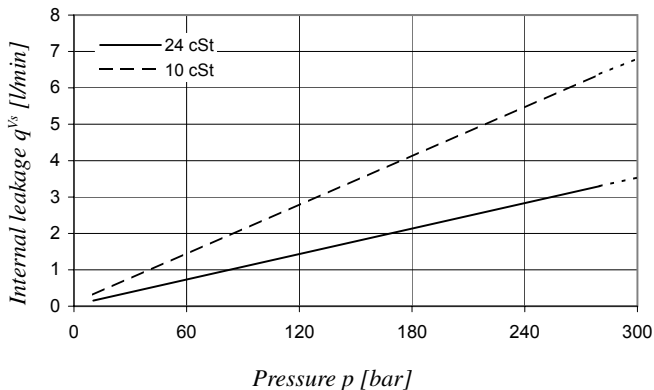

Do not operate pump more than 5 seconds at any speed or viscosity if internal leakage is higher than 50% of theoretical flow.

NOISE LEVEL (TYPICAL) - T7ASW B28

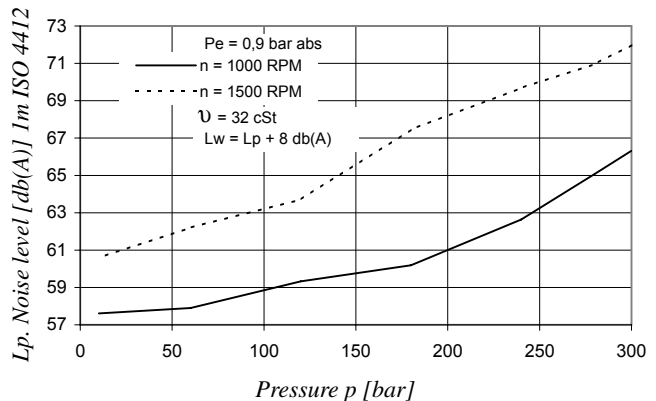

POWER LOSS HYDROMECHANICAL (TYPICAL)

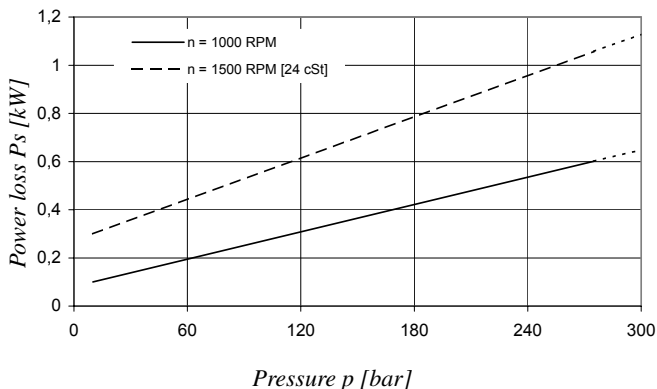

* Cartridge designation is now in ml/rev. (example : B26 = 26 ml/rev.)

PERMISSIBLE RADIAL LOAD

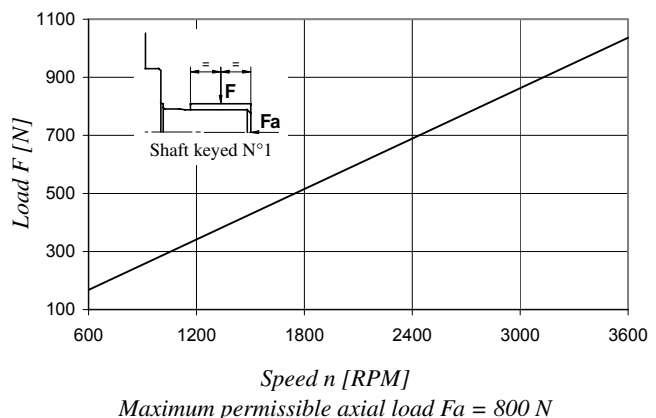

Maximum permissible axial load Fa = 800 N

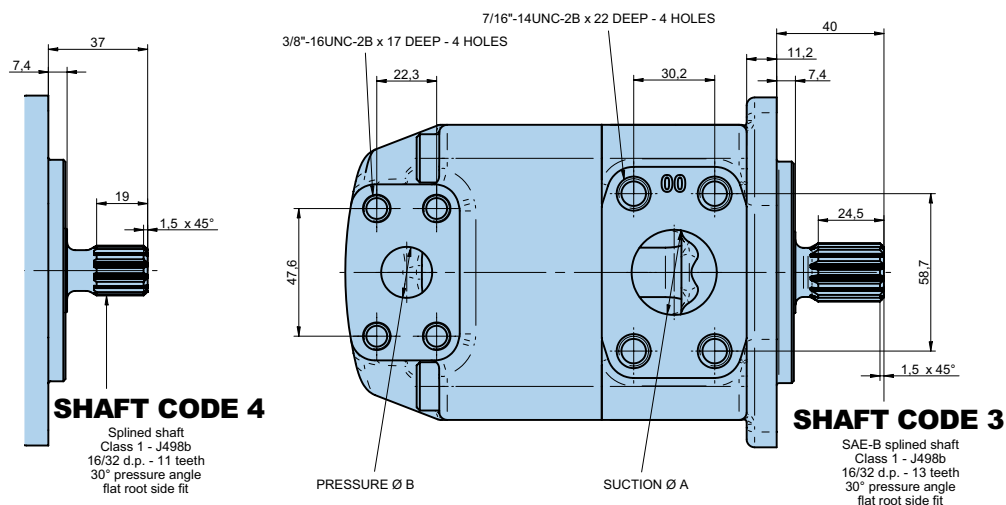
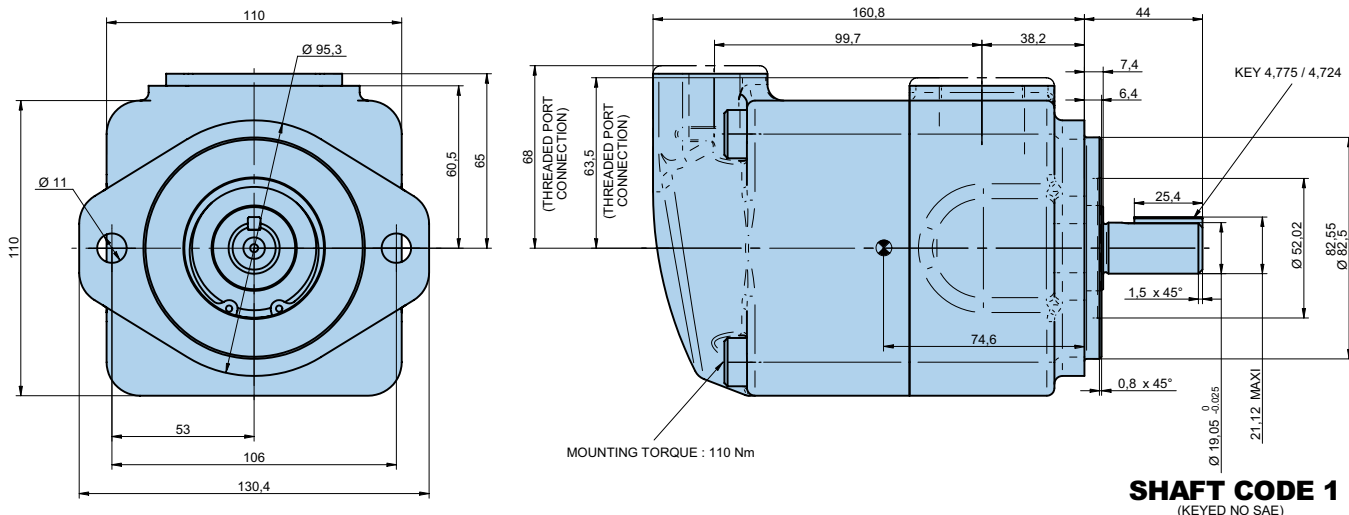

Code	00	02	03	04
A	Ø 31,80	SAE # 20 1.5/8" - 12 UNF - 2B	1.1/14" NPTF	1.1/4" BSP
B	Ø 19,05	SAE # 12 1.1/16" - 12 UNF - 2B	SAE # 12 1.1/16" - 12 UNF - 2B	3/4" BSP

Shaft torque limits [ml/rev. x bar]	
Shaft	Vi x p max.
1	18530
3	18530
4	12660



If inlet velocity > 1,9 m/s, please contact Parker.

OPERATING CHARACTERISTICS - TYPICAL [24 cSt]

Pressure port	Series	Vi Volumetric displacement	Flow q _v [l/min] & n = 1500 RPM			Input power P [kW] & n = 1500 RPM		
			p = 0 bar	p = 140 bar	p = 300 bar	p = 7 bar	p = 140 bar	p = 300 bar
T7ASW	B26	26,0 ml/rev	39,0	37,3	35,5	0,8	9,5	20,6
	B28	28,0 ml/rev	42,0	40,3	38,5	0,9	10,2	22,1
	B30	30,0 ml/rev	45,0	43,3	41,5	0,9	10,9	23,6
	B32	31,8 ml/rev	47,7	46,0	44,2	0,9	11,6	25,0
	B34	34,0 ml/rev	51,0	49,3	47,5 ¹⁾	1,0	12,3	26,6 ¹⁾
	B36	36,0 ml/rev	54,0	52,3	50,5 ¹⁾	1,0	13,0	28,1 ¹⁾
	B40	40,0 ml/rev	60,0	58,3	56,5 ¹⁾	1,1	14,4	31,1 ¹⁾

¹⁾ B34 - B36 - B40 = 280 bar max. int.

Model No.

T7B or T7BS - B10 - 1 R 00 - A 1 - M0 - ..

T7B series - 100 A2 HW
ISO 2 bolts 3019-2 mounting flange

T7BS series - SAE B 2 bolts
J744 mounting flange

Displacement

Volumetric displacement (ml/rev.)
 B02 = 5,8 B07 = 22,5 B11 = 35,0
 B03 = 9,8 B08 = 24,9 B12 = 41,0
 B04 = 12,8 B09 = 28,0 B14 = 45,0
 B05 = 15,9 B10 = 31,8 B15 = 50,0
 B06 = 19,8

Type of shaft T7B - T7BS
2 = keyed (ISO R775)

Type of shaft T7BS
 1 = keyed (SAE B) Ø 22,2
 3 = splined (SAE B) 13 teeth
 4 = splined (SAE BB) 15 teeth

Modifications

Mounting w/connection variables
4 bolts SAE flange J518

	T7B-T7BS		T7BS	
	Metric thread	UNC thread	00	01
P	1"	3/4"	1"	3/4"
S	1.1/2"			

Seal class

1 = S1 BUNA N - 0,7 bar max. (for mineral oil)
 4 = S4 EPDM - 0,7 bar max. (for fire resistant fluids)
 5 = S5 VITON® - 0,7 bar max. (for mineral oil and fire resistant fluids)

Design letter

Porting combination

00 = standard

Direction of rotation (shaft end view)

R = Clockwise
 L = Counter-clockwise

P = Pressure port
 S = Suction port

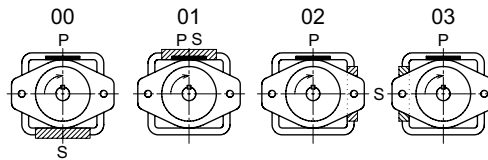

INTERNAL LEAKAGE (TYPICAL)

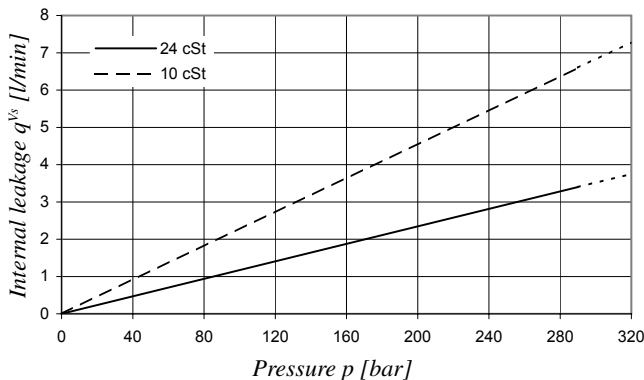

Do not operate pump more than 5 seconds at any speed or viscosity if internal leakage is higher than 50% of theoretical flow.

NOISE LEVEL (TYPICAL) - T7B - B10

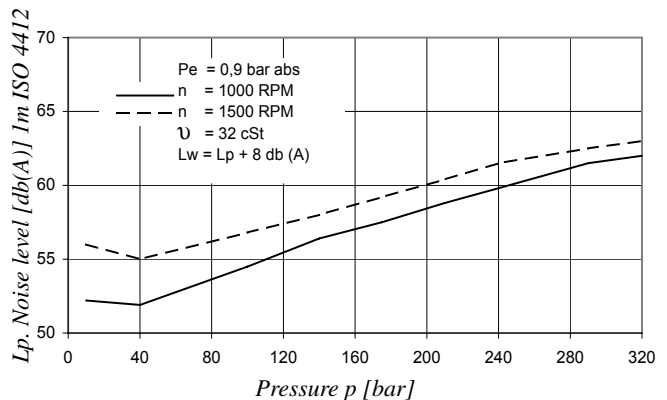

POWER LOSS HYDROMECHANICAL (TYPICAL)

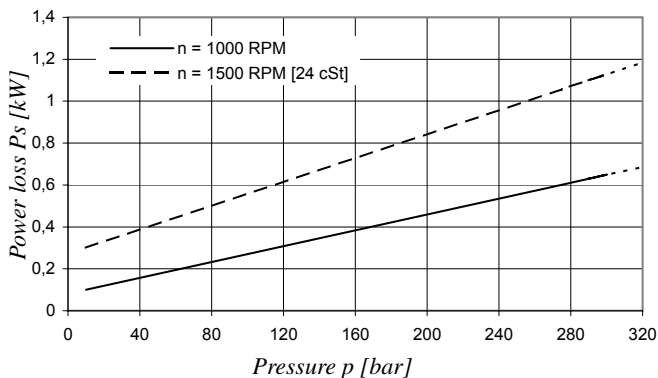

PERMISSIBLE RADIAL LOAD

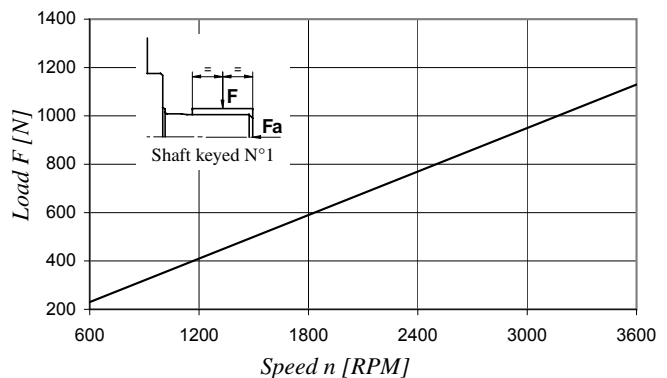

Maximum permissible axial load Fa = 800 N

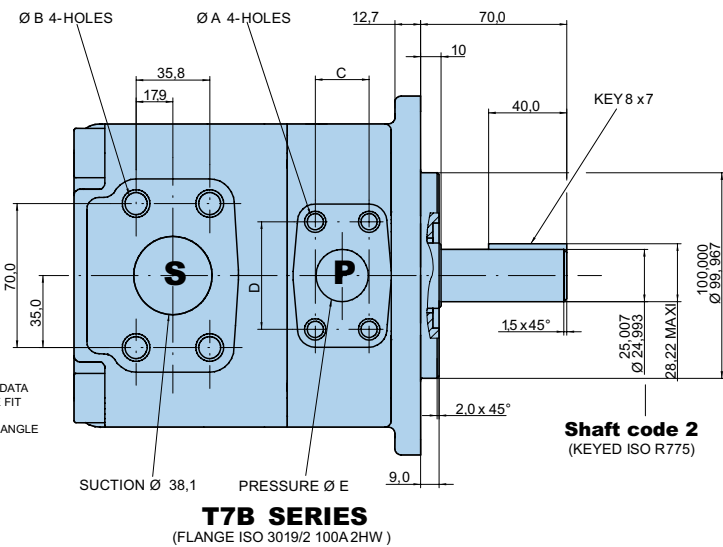
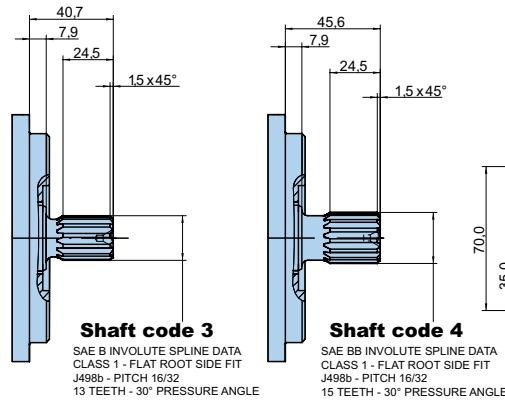
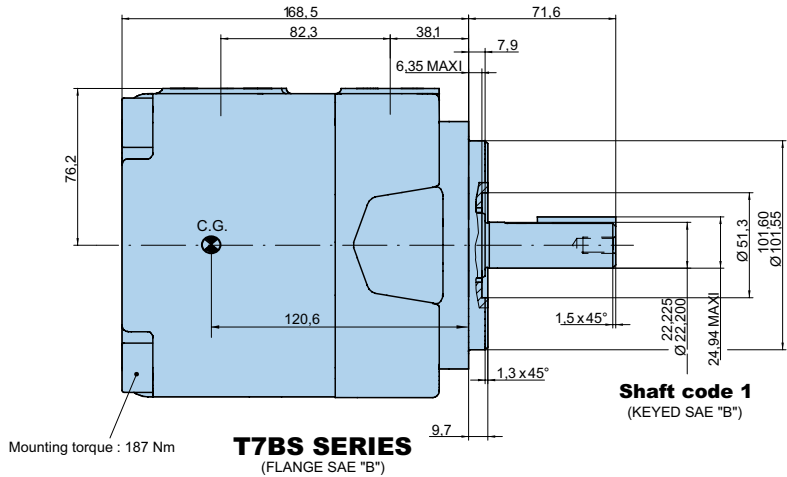
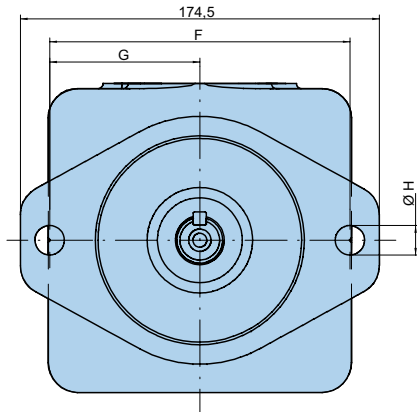

Model	T7B		T7BS	
	M0	M1	00	01
Ø A	M10 x 19 deep		3/8"-16 UNC x 19 deep	
Ø B	M12 x 22,4 deep		1/2"-13 UNC x 22,4 deep	
C	26,20	22,25	26,20	22,25
D	52,4	47,65	52,4	47,65
Ø E	25,4	19,1	25,4	19,1
F	140		146	
G	70		73	
Ø H	14,0		14,3	

Shaft torque limits [ml/rev. x bar]	
Shaft	Vi x p max.
1	16500
2	20600
3	20600
4	20600

OPERATING CHARACTERISTICS - TYPICAL [24 cSt]

Pressure port	Series	Vi Volumetric displacement	Flow q _v [l/min] & n = 1500 RPM			Input power P [kW] & n = 1500 RPM		
			p = 0 bar	p = 140 bar	p = 320 bar	p = 7 bar	p = 140 abr	p = 320 bar
T7B T7BS	B02	5,8 ml/rev	8,7	7,0	4,8	0,5	2,6	5,4
	B03	9,8 ml/rev	14,7	13,0	10,8	0,6	4,0	8,6
	B04	12,8 ml/rev	19,2	17,5	15,3	0,6	5,0	11,0
	B05	15,9 ml/rev	23,9	22,2	20,0	0,7	6,1	13,5
	B06	19,8 ml/rev	29,7	28,0	25,8	0,7	7,5	16,6
	B07	22,5 ml/rev	33,7	32,0	29,9	0,8	8,5	18,8
	B08	24,9 ml/rev	37,4	35,7	33,5	0,8	9,3	20,7
	B09	28,0 ml/rev	42,0	40,3	38,1	0,9	10,4	23,2
	B10	31,8 ml/rev	47,7	46,0	43,8	0,9	11,7	26,2
	B11	35,0 ml/rev	52,5	50,8	48,9 ¹⁾	1,0	12,8	27,0 ¹⁾
	B12	41,0 ml/rev	61,5	59,8	57,9 ¹⁾	1,1	14,9	31,5 ¹⁾
	B14	45,0 ml/rev	67,5	65,8	63,9 ¹⁾	1,2	16,3	34,5 ¹⁾
B15	50,0 ml/rev	75,0	73,3	71,6 ²⁾	1,3	18,1	35,7 ²⁾	

1) B11 - B12 - B14 = 300 bar max. int.

2) B15 = 280 bar max. int.

Model No.

T6C* - 022 - 1 R 00 - B 1 - ..

Series - SAE B 2 bolts

J744 mounting flange

* Rear drive option available, please contact Parker

Displacement

Volumetric displacement (ml/rev.)

003 = 10,8	017 = 58,3
005 = 17,2	020 = 63,8
006 = 21,3	022 = 70,3
008 = 26,4	025 = 79,3
010 = 34,1	028 = 88,8
012 = 37,1	031 = 100,0
014 = 46,0	

Type of shaft

1 = keyed (SAE B) Ø 22,2

2 = keyed (non SAE)

3 = splined (SAE B) 13 teeth

4 = splined (SAE BB) 15 teeth

Modifications

Seal class

1 = S1 BUNA N - 0,7 bar max. (for mineral oil)

4 = S4 EPDM - 7 bar max. (for fire resistant fluids)

5 = S5 VITON® - 7 bar max. (for mineral oil and fire resistant fluids)

Design letter

Porting combination

00 = standard

Direction of rotation (shaft end view)

R = Clockwise

L = Counter-clockwise

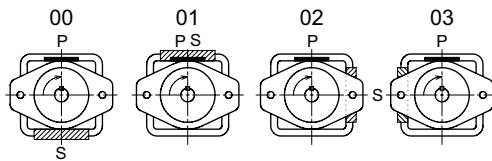

P = Pressure port
 S = Suction port

INTERNAL LEAKAGE (TYPICAL)

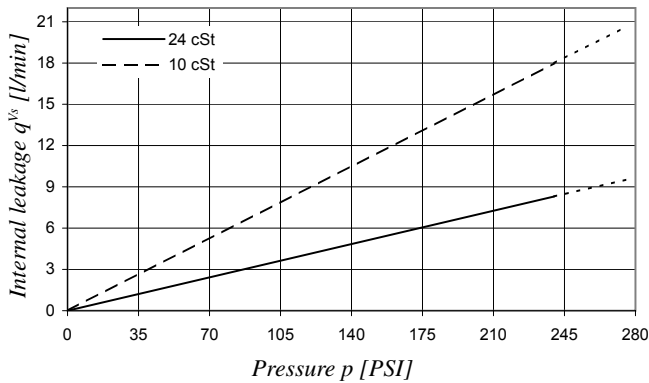

Do not operate pump more than 5 seconds at any speed or viscosity if internal leakage is higher than 50% of theoretical flow.

NOISE LEVEL (TYPICAL) - T6C - 022

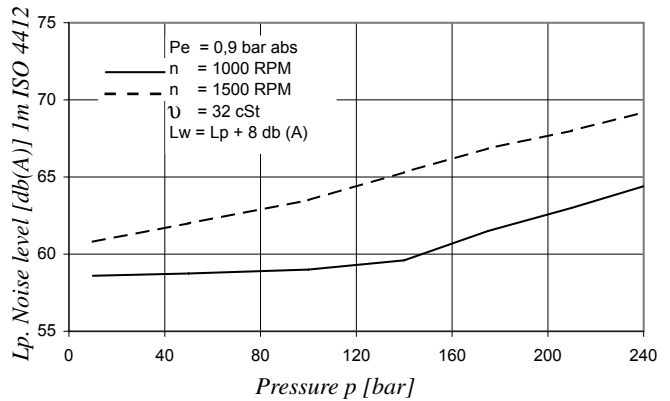

POWER LOSS HYDROMECHANICAL (TYPICAL)

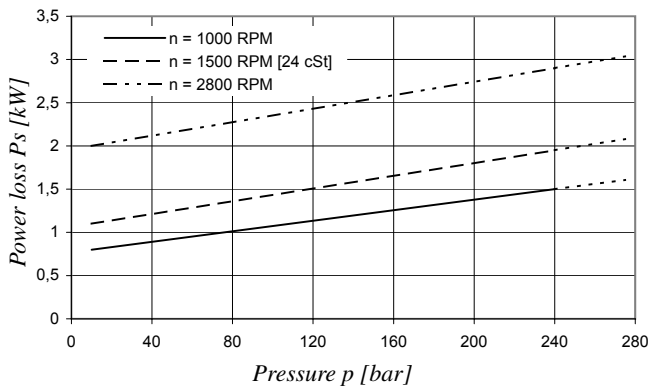

PERMISSIBLE RADIAL LOAD

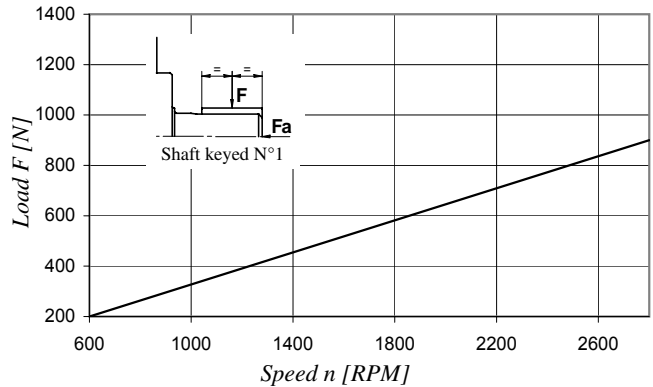

Maximum permissible axial load Fa = 800 N

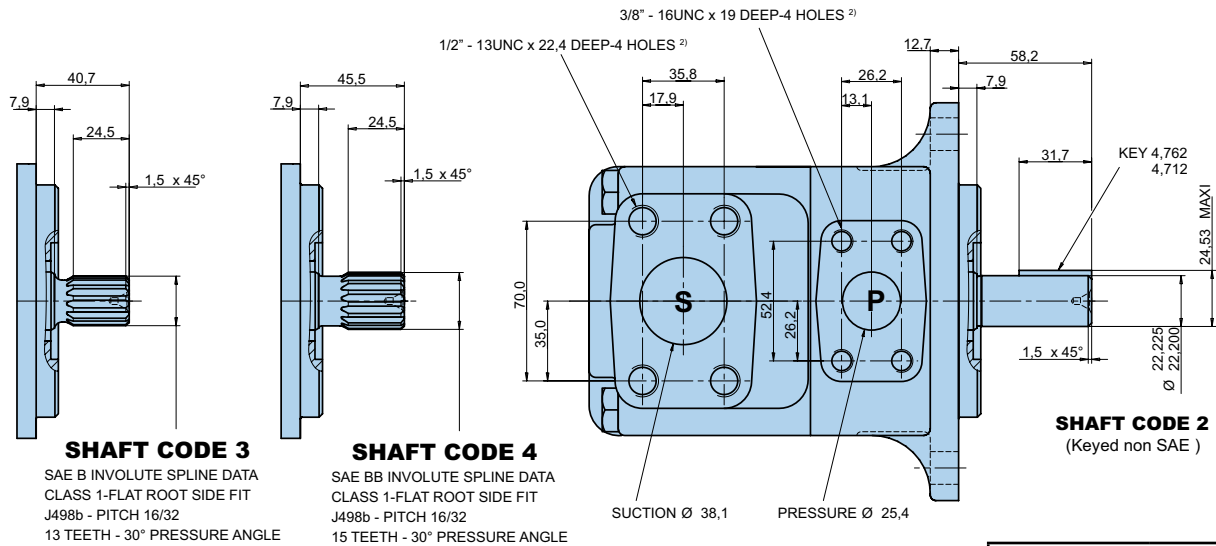
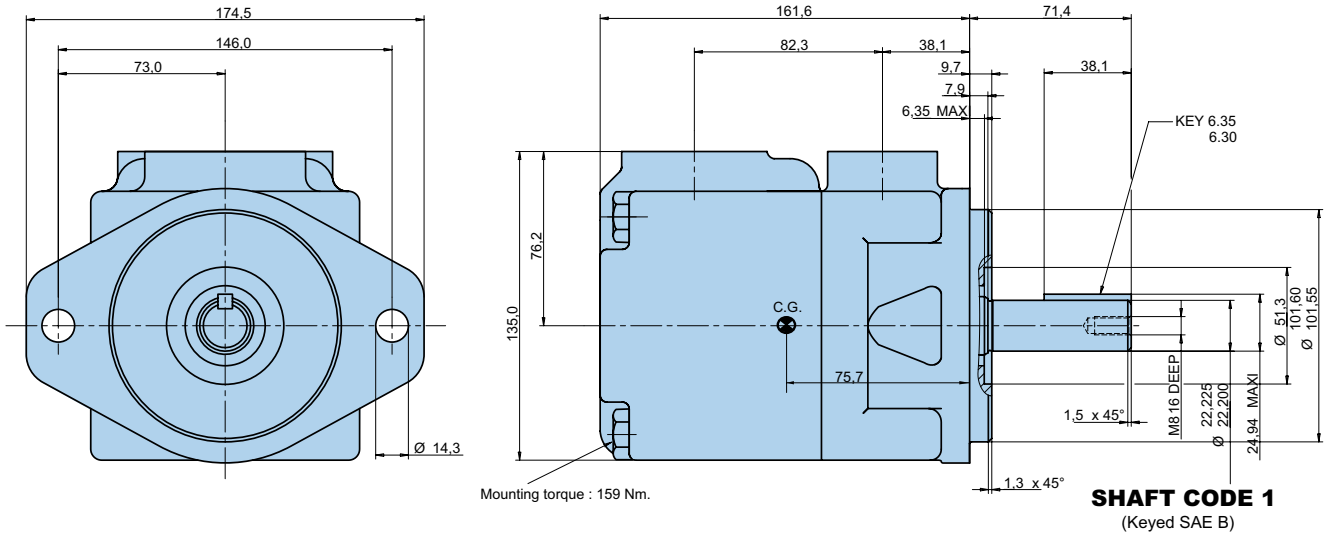

Shaft torque limits [ml/rev. x bar]	
Shaft	Vi x p max.
1	16340
2	14300
3	20600
4	21800

OPERATING CHARACTERISTICS - TYPICAL [24 cSt]

Pressure port	Series	Vi Volumetric displacement	Flow q _v [l/min] & n = 1500 RPM			Input power P [kW] & n = 1500 RPM		
			p = 0 bar	p = 140 bar	p = 240 bar	p = 7 bar	p = 140 bar	p = 240 bar
T6C	003	10,8 ml/rev	16,2	11,2	7,7	1,3	5,3	8,4
	005	17,2 ml/rev	25,8	20,8	17,3	1,4	7,5	12,2
	006	21,3 ml/rev	31,9	26,9	23,4	1,5	8,9	14,7
	008	26,4 ml/rev	39,6	34,6	31,1	1,6	10,7	17,7
	010	34,1 ml/rev	51,1	46,1	42,6	1,7	13,4	22,3
	012	37,1 ml/rev	55,6	50,6	47,1	1,7	14,4	24,1
	014	46,0 ml/rev	69,0	64,0	60,5	1,9	17,6	29,5
	017	58,3 ml/rev	87,4	82,4	78,9	2,1	21,9	36,9
	020	63,8 ml/rev	95,7	90,7	87,2	2,2	23,8	40,2
	022	70,3 ml/rev	105,4	100,4	96,9	2,3	26,1	44,1
	025	79,3 ml/rev	118,9	113,9	110,4	2,5	29,2	49,5
	028	88,8 ml/rev	133,2	128,2	125,8 ¹⁾	2,8	32,7	48,5 ¹⁾
031	100,0 ml/rev	150,0	145,0	142,6 ¹⁾	2,8	36,5	54,4 ¹⁾	

¹⁾ 028 - 031 = 210 bar max. int.

²⁾ Port connection can be supplied with metric threads (Please contact Parker).

Model No.

T7D* or T7DS - B42 - 1 R 00 - A 1 - M0 - ..

T7D series - 125 A2 HW
ISO 2 bolts 3019-2 mounting flange

T7DS series - SAE C 2 bolts
J744 mounting flange

* Rear drive option available, please contact Parker

Displacement

Volumetric displacement (ml/rev.)

- B14 = 44,0 B31 = 99,2
- B17 = 55,0 B35 = 113,4
- B20 = 66,0 B38 = 120,6
- B22 = 70,3 B42 = 137,5
- B24 = 81,1 045 = 145,7
- B28 = 90,0 050 = 158,0

Type of shaft T7D - T7DS

5 = keyed (ISO 3019-2 - G32M)

Type of shaft T7DS

- 1 = keyed (SAE C) Ø 31,7
- 2 = keyed (non SAE)
- 3 = splined (SAE C) 14 teeth
- 4 = splined (non SAE)

Modifications

Mounting w/connection variables

4 bolts SAE flange J518

	P = 1.1/4" - S = 2"	
	Metric thread	UNC thread
T7D	M0	
T7DS	M0	Y0 ¹⁾ 00

¹⁾ 250 bar max. int.

Seal class

- 1 = S1 BUNA N - 0,7 bar max. (for mineral oil)
- 4 = S4 EPDM - 7 bar max. (for fire resistant fluids)
- 5 = S5 VITON® - 7 bar max. (for mineral oil and fire resistant fluids)

Design letter

Porting combination

00 = standard

Direction of rotation (shaft end view)

- R = Clockwise
- L = Counter-clockwise

- P = Pressure port
- S = Suction port

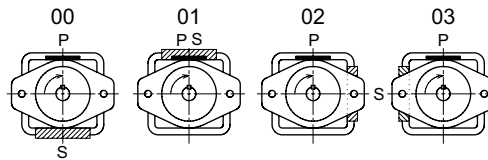

INTERNAL LEAKAGE (TYPICAL)

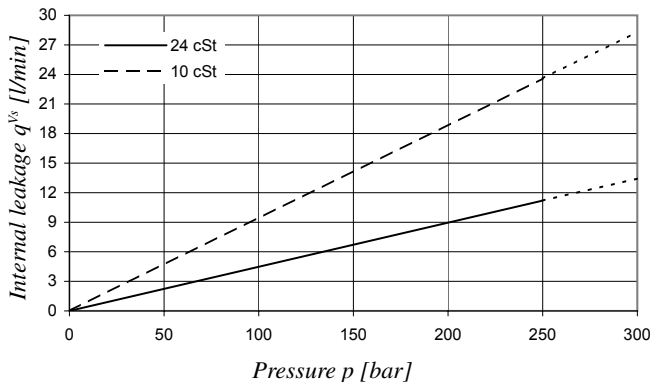

Do not operate pump more than 5 seconds at any speed or viscosity if internal leakage is higher than 50% of theoretical flow.

NOISE LEVEL (TYPICAL) - T7D - B31

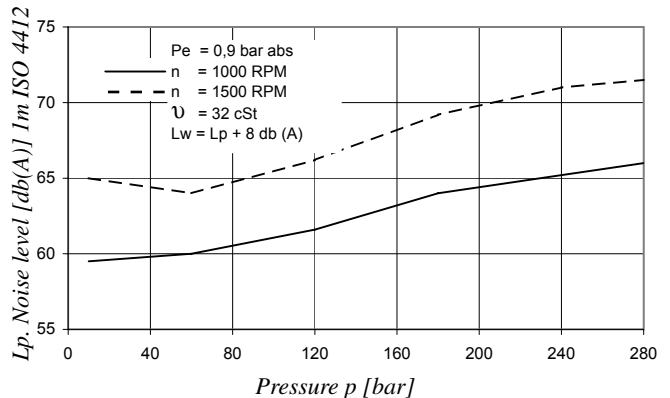

POWER LOSS HYDROMECHANICAL (TYPICAL)

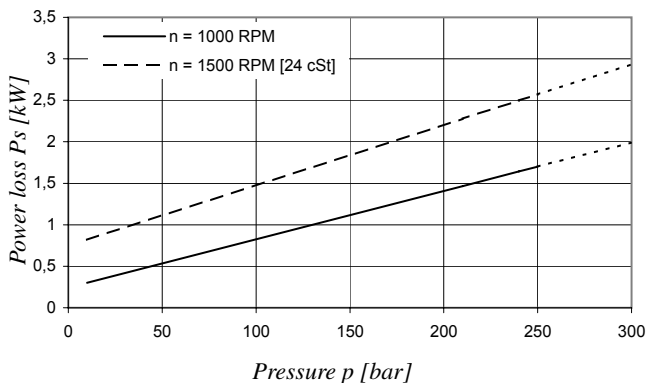

PERMISSIBLE RADIAL LOAD

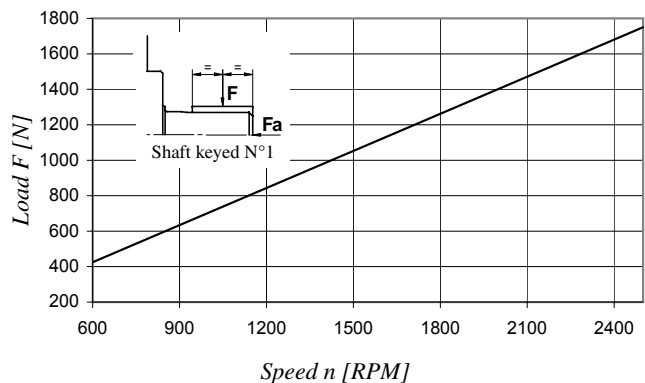

Maximum permissible axial load Fa = 1200 N

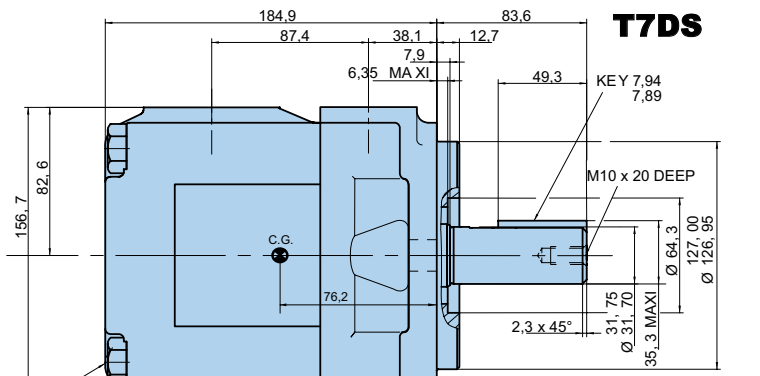
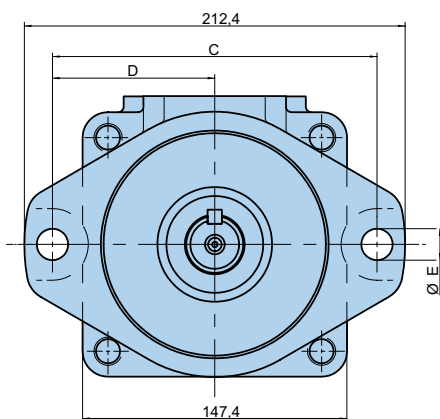

T7DS
SHAFT CODE 1
(Keyed SAE C)

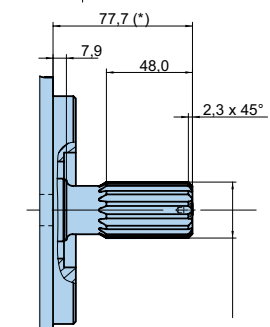

SHAFT CODE 4

SAE C Spc (*) INVOLUTE SPLINE DATA
CLASS 1-FLAT ROOT SIDE FIT
J498 b - PITCH 12/24
14 TEETH - 30° PRESSURE ANGLE

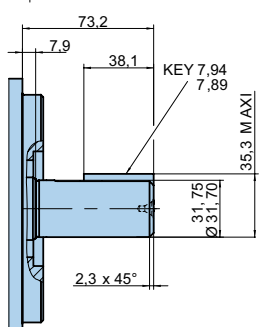

SHAFT CODE 2

(Keyed non SAE)

MOUNTING TORQUE : 187 Nm

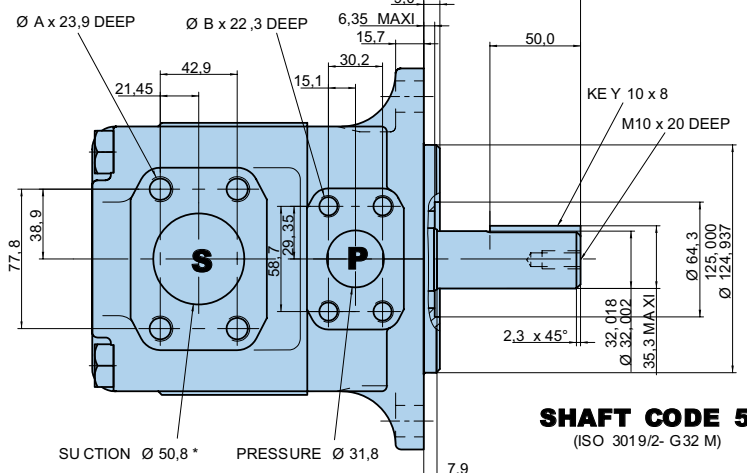

SHAFT CODE 5
(ISO 3019/2- G32 M)

T7D

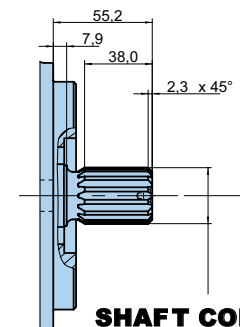

SHAFT CODE 3

SAE C INVOLUTE SPLINE DATA
CLASS 1-FLAT ROOT SIDE FIT
J498b - PITCH 12/24
14 TEETH - 30° PRESSURE ANGLE

Model	T7D	T7DS		
Code	M0	00	M0	YO ¹⁾
Ø A	M12	1/2" - 13 UNC	M12	M12
Ø B	M12	7/16" - 14 UNC	M12	M10
C	180,0	181,0		
D	90,0	90,5		
Ø E	18,0	17,5		

¹⁾ 250 bar max. int.

Shaft torque limits [ml/rev. x bar]	
Shaft	Vi x p max.
1	43240
2	34590
3	61200
4	61200
5	44300

OPERATING CHARACTERISTICS - TYPICAL [24 cSt]

Pressure port	Series	Vi Volumetric displacement	Flow q _v [l/min] & n = 1500 RPM			Input power P [kW] & n = 1500 RPM		
			p = 0 bar	p = 140 bar	p = 300 bar	p = 7 bar	p = 140 bar	p = 300 bar
T7D T7DS	B14	44,0 ml/rev	66,0	59,4	51,9	1,5	16,6	34,2
	B17	55,0 ml/rev	82,5	75,9	68,4	1,7	20,4	42,4
	B20	66,0 ml/rev	99,0	92,4	84,9	1,9	24,3	50,7
	B22	70,3 ml/rev	105,5	98,8	91,3	2,0	25,8	53,9
	B24	81,1 ml/rev	121,7	115,0	107,5	2,2	29,5	62,0
	B28	90,0 ml/rev	135,0	128,4	120,9	2,3	32,7	68,7
	B31	99,2 ml/rev	148,8	142,2	134,7	2,5	35,9	75,6
	B35	113,4 ml/rev	170,1	163,5	156,9 ¹⁾	2,7	40,8	80,5 ¹⁾
	B38	120,6 ml/rev	180,9	174,3	167,7 ¹⁾	2,9	43,4	85,6 ¹⁾
	B42	137,5 ml/rev	206,3	199,6	194,0 ²⁾	3,2	49,3	90,5 ²⁾
	045	145,7 ml/rev	218,6	209,2	202,6 ³⁾	4,1	52,8	89,5 ³⁾
050	158,0 ml/rev	237,0	227,7	223,0 ⁴⁾	4,4	57,1	85,0 ⁴⁾	

¹⁾ B35 - B38 = 280 bar max. int. ²⁾ B42 = 260 bar max. int. ³⁾ 045 = 240 bar max. int. ⁴⁾ 050 = 210 bar max. int.

* special 2.1/2" (Ø 63,5) suction also available - Please contact Parker.



T7E / T7ES - Ordering Code

T7/T67/T6C Industrial, Denison Vane Pumps

Model No. T7E* or T7ES - 072 - 1 R 00 - A 1 - M0 - ..

T7E series - 125 A2 HW
ISO 2 bolts 3019-2 mounting flange

T7ES series - SAE C 2 bolts
J744 mounting flange

* Rear drive option available, please contact Parker.

Displacement
Volumetric displacement (ml/rev.)

- 042 = 132,3 057 = 183,3
- 045 = 142,4 062 = 196,7
- 050 = 158,5 066 = 213,3
- 052 = 164,8 072 = 227,1
- 054 = 171,0 085 = 268,7

Type of shaft T7E - T7ES
5 = keyed (ISO R775 - G38M)

Type of shaft T7ES
1 = keyed (SAE CC)
2 = keyed (non SAE)
3 = splined (SAE C) 14 teeth
4 = splined (SAE CC) 17 teeth

Modifications

Mounting w/connection variables

4 bolts SAE flange J518

	T7E - T7ES Metric thread	T7ES UNC thread
	M0	00
P	1.1/2"	
S	3"	

Seal class

- 1 = S1 BUNA N - 0,7 bar max. (for mineral oil)
- 4 = S4 EPDM - 7 bar max. (for fire resistant fluids)
- 5 = S5 VITON® - 7 bar max. (for mineral oil and fire resistant fluids)

Design letter

Porting combination
00 = standard

Direction of rotation (shaft end view)

- R = Clockwise
- L = Counter-clockwise

P = Pressure port
S = Suction port

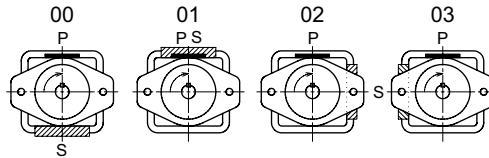

INTERNAL LEAKAGE (TYPICAL)

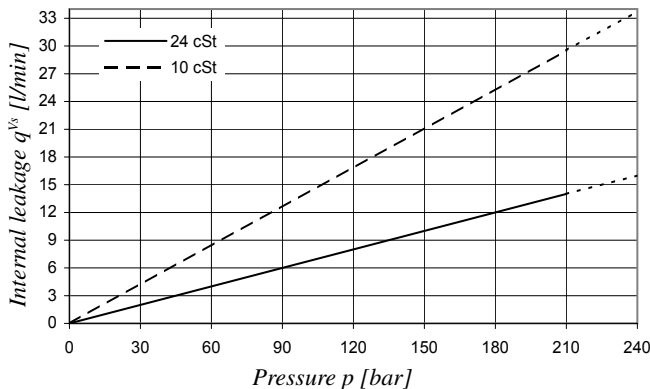

Do not operate pump more than 5 seconds at any speed or viscosity if internal leakage is higher than 50% of theoretical flow.

NOISE LEVEL (TYPICAL) - T7ES - 050

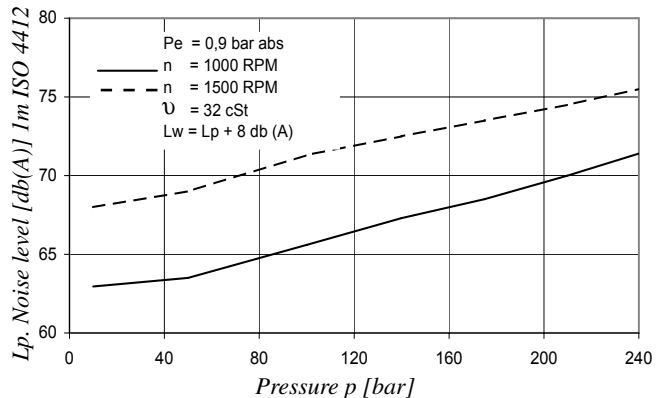

POWER LOSS HYDROMECHANICAL (TYPICAL)

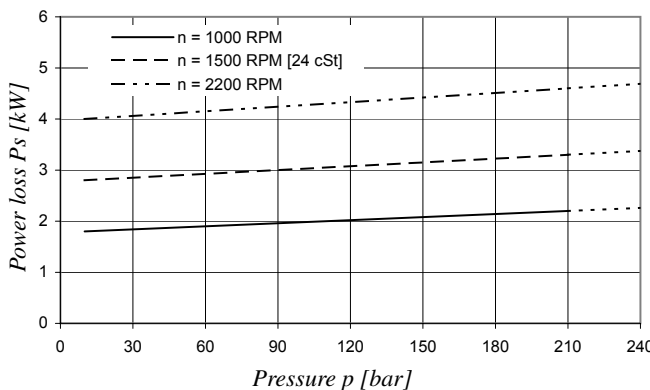

PERMISSIBLE RADIAL LOAD

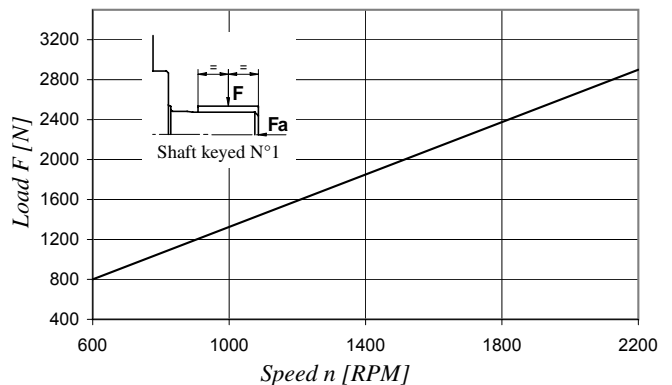

Maximum permissible axial load Fa = 2000 N

Model No. T7BB or T7BBS - B10 - B10 - 1 R 00 - A 1 - M1 - ..

T7BB series - 100 A2 HW
ISO 2 bolts 3019-2 mounting flange

T7BBS series - SAE B 2 bolts
J744 mounting flange

Displacement P1 & P2
Volumetric displacement (ml/rev.)

- B02 = 5,8 B09 = 28,0
- B03 = 9,8 B10 = 31,8
- B04 = 12,8 B11 = 35,0
- B05 = 15,9 B12 = 41,0
- B06 = 19,8 B14 = 45,0
- B07 = 22,5 B15 = 50,0
- B08 = 24,9

Type of shaft T7BB - T7BBS
5 = keyed (ISO R775)

Type of shaft T7BBS
1 = keyed (non SAE)
2 = keyed (SAE BB)
3 = splined (SAE B) 13 teeth
4 = splined (SAE BB) 15 teeth

Modifications

Mounting w/connection variables
4 bolts SAE flange J518

	T7BB- T7BBS Metric thread		T7BBS UNC thread	
	M0	M1	00	01
P1	1"	3/4"	1"	3/4"
P2	3/4"			
S	2.1/2"			

Seal class

- 1 = S1 BUNA N - 0,7 bar max. (for mineral oil)
- 4 = S4 EPDM - 0,7 bar max. (for fire resistant fluids)
- 5 = S5 VITON® - 0,7 bar max. (for mineral oil and fire resistant fluids)

Design letter

Porting combination (see page 72)
00 = standard

Direction of rotation (shaft end view)
R = Clockwise
L = Counter-clockwise

INTERNAL LEAKAGE (TYPICAL)

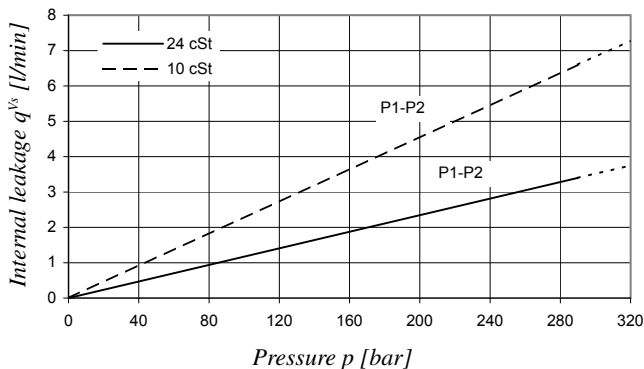

Do not operate pump more than 5 seconds at any speed or viscosity if internal leakage is higher than 50% of theoretical flow. Total leakage is the sum of each section loss under its respective operating conditions.

POWER LOSS HYDROMECHANICAL (TYPICAL)

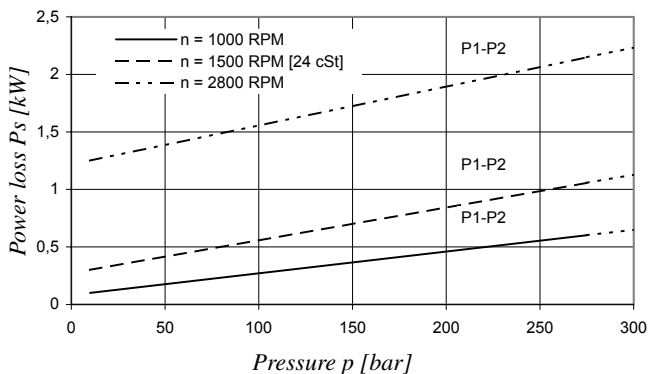

Total hydromechanical power loss is the sum of each section loss under its respective operating conditions.

NOISE LEVEL (TYPICAL) - T7BB - B10 - B04

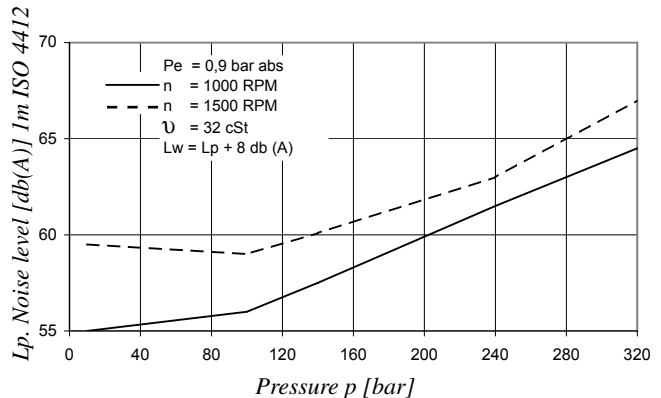

Double pump noise level is given with both stages discharging at the pressure value indicated on the curve.

PERMISSIBLE RADIAL LOAD

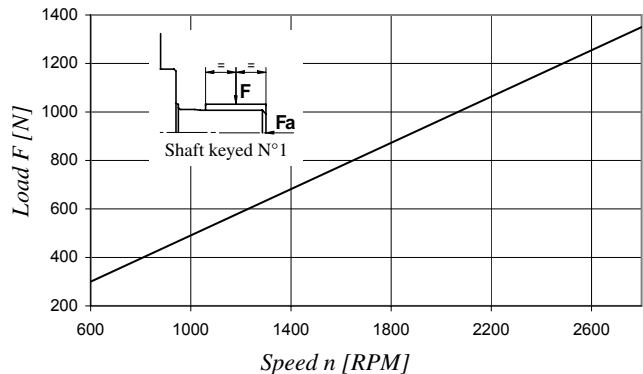

Maximum permissible axial load Fa = 800 N

Model No. **T6CC W - 022 - 008 - 1 R 00 - C 1 00 - ..**

Series - SAE B 2 bolts **J744 mounting flange** **P1** **P2**

Severe duty shaft option

Displacement P1 and P2

Volumetric displacement (ml/rev.)

003 = 10,8 017 = 58,3
 005 = 17,2 020 = 63,8
 006 = 21,3 022 = 70,3
 008 = 26,4 025 = 79,3
 010 = 34,1 028 = 88,8
 012 = 37,1 031 = 100,0
 014 = 46,0

Type of shaft **Severe duty shaft (T6CCW only)**

1 = keyed (non SAE) 2 = keyed (SAE BB)
 3 = splined (SAE BB) 15 teeth
 5 = splined (SAE B) 13 teeth

Direction of rotation (shaft end view)

R = Clockwise
 L = Counter-clockwise

Modifications

Mounting w/connection variables

P2	P1 = 1" - S = 3"			
	UNC thread		Metric thread	
	00	01	0M	W0
	1"	3/4" ¹⁾	1"	3/4

P2	P1 = 1" - S = 2.1/2" ²⁾			
	UNC thread		Metric thread	
	10	11	1M	W1
	1"	3/4" ¹⁾	1"	3/4

¹⁾ up to 46 ml/rev. max.

²⁾ up to 126 ml/rev. max.

Always select the largest cartridge in the front place.

Seal class

1 = S1 BUNA N - 0,7 bar max. (for mineral oil)
 4 = S4 EPDM - 7 bar max. (for fire resistant fluids)
 5 = S5 VITON® - 7 bar max. (for mineral oil and fire resistant fluids)

Design letter

Porting combination (see page 72)

00 = standard

INTERNAL LEAKAGE (TYPICAL)

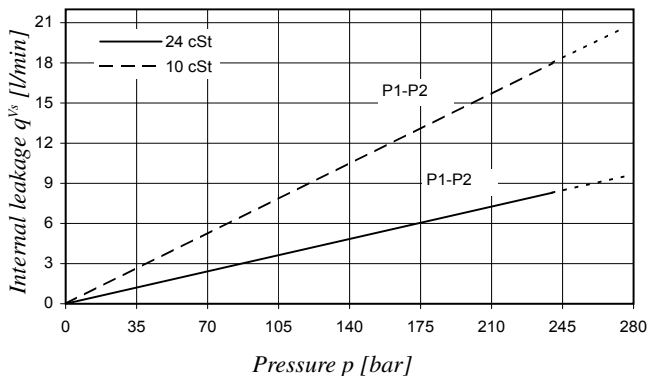

Do not operate pump more than 5 seconds at any speed or viscosity if internal leakage is higher than 50% of theoretical flow. Total leakage is the sum of each section loss under its respective operating conditions.

POWER LOSS HYDROMECHANICAL (TYPICAL)

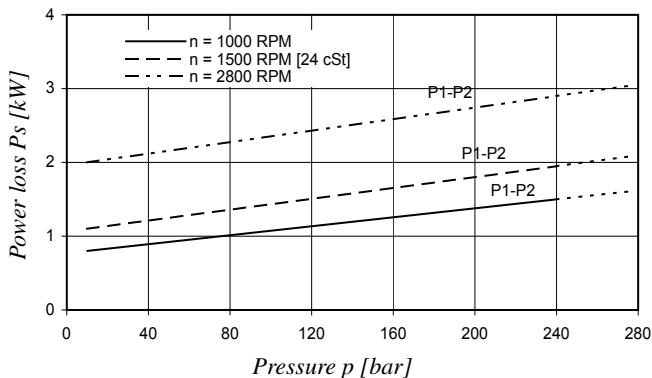

Total hydromechanical power loss is the sum of each section loss under its respective operating conditions.

NOISE LEVEL (TYPICAL) - T6CC - 022 - 022

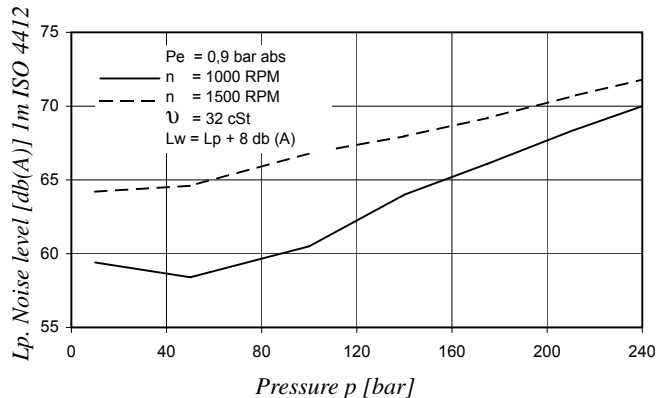

Double pump noise level is given with both stages discharging at the pressure value indicated on the curve.

PERMISSIBLE RADIAL LOAD

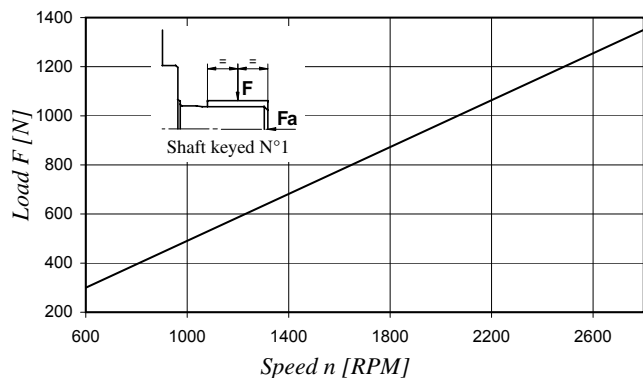

Maximum permissible axial load Fa = 800 N

Model No. T67CB W - 010 - B10 - 1 R 00 - A 1 M1 - ..

Series - SAE B 2 bolts
 J744 mounting flange
Severe duty shaft

Displacement P1
 Volumetric displacement (ml/rev.)
 003 = 10,8 017 = 58,3
 005 = 17,2 020 = 63,8
 006 = 21,3 022 = 70,3
 008 = 26,4 025 = 79,3
 010 = 34,1 028 = 88,8
 012 = 37,1 031 = 100,0
 014 = 46,0

Displacement P2
 Volumetric displacement (ml/rev.)
 B02 = 5,8 B09 = 28,0
 B03 = 9,8 B10 = 31,8
 B04 = 12,8 B11 = 35,0
 B05 = 15,9 B12 = 41,0
 B06 = 19,8 B14 = 45,0
 B07 = 22,5 B15 = 50,0
 B08 = 24,9

Type of shaft **Severe duty shaft (T67CW only)**
 1 = keyed (non SAE) 2 = keyed (SAE BB)
 3 = splined (SAE BB) 15 teeth
 5 = splined (SAE B) 13 teeth

Modifications

Mounting w/connection variables
 11 = 4 bolts SAE flange (J518) UNC thread
 M1 = 4 bolts SAE flange (J518) Metric thread

Seal class
 1 = S1 BUNA N - 0,7 bar max. (for mineral oil)
 4 = S4 EPDM - 7 bar max. (for fire resistant fluids)
 5 = S5 VITON® - 7 bar max. (for mineral oil and fire resistant fluids)

Design letter

Porting combination(see page 72)
 00 = standard

Direction of rotation (shaft end view)
 R = Clockwise
 L = Counter-clockwise

INTERNAL LEAKAGE (TYPICAL)

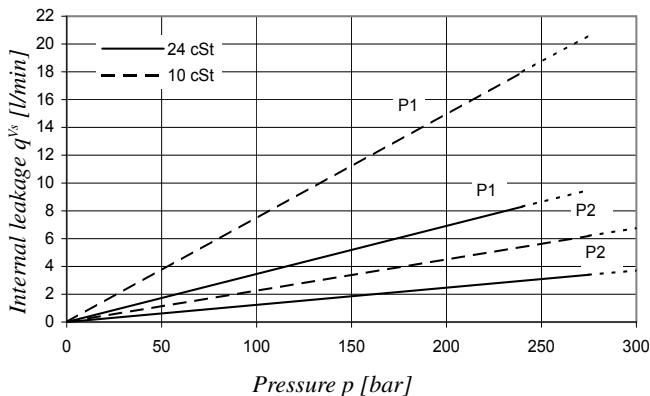

Do not operate pump more than 5 seconds at any speed or viscosity if internal leakage is higher than 50% of theoretical flow.
 Total leakage is the sum of each section loss under its respective operating conditions.

NOISE LEVEL (TYPICAL) - T67CB - 014 - B03

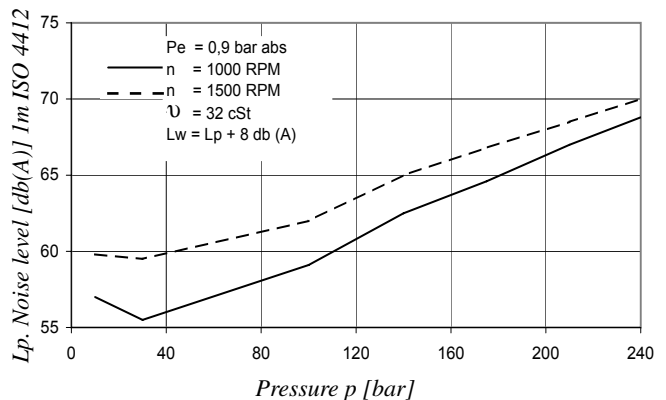

Double pump noise level is given with both stages discharging at the pressure value indicated on the curve.

POWER LOSS HYDROMECHANICAL (TYPICAL)

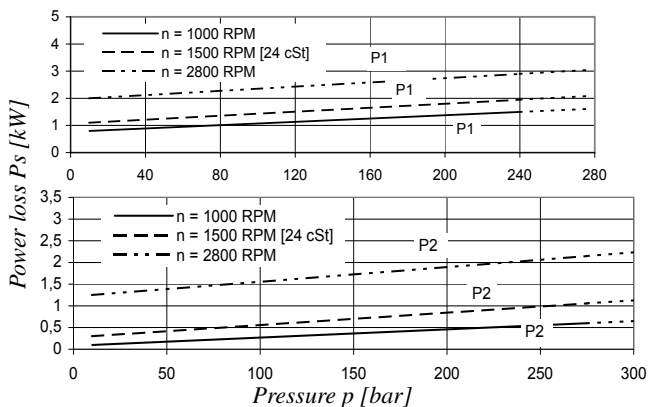

Total hydromechanical power loss is the sum of each section loss under its respective operating conditions.

PERMISSIBLE RADIAL LOAD

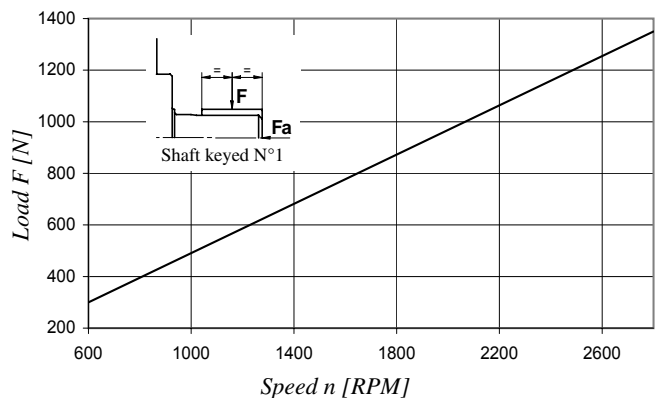

Maximum permissible axial load $F_a = 800$ N

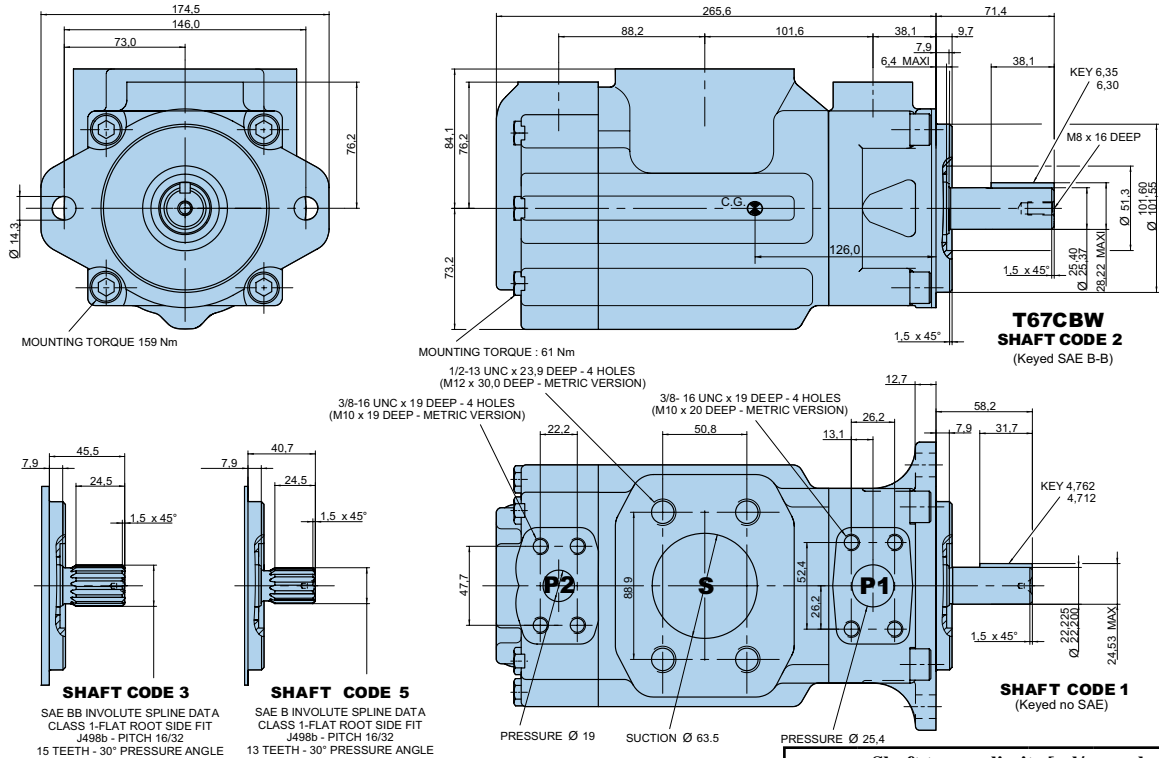

Shaft torque limits [ml/rev. x bar]			
Shaft	Vi x p max.	Shaft	Vi x p max.
1	14300	3	32670
2	21420	5	20600

OPERATING CHARACTERISTICS - TYPICAL [24 cSt]

Pressure port	Series	Vi Volumetric displacement	Flow q _v [l/min] & n = 1500 RPM			Input power P [kW] & n = 1500 RPM		
			p = 0 bar	p = 140 bar	p = 275 bar	p = 7 bar	p = 140 bar	p = 275 bar
P1	003	10,8 ml/rev	16,2	11,2	*	1,3	5,3	*
	005	17,2 ml/rev	25,8	20,8	16,1	1,4	7,5	13,9
	006	21,3 ml/rev	31,9	26,9	22,2	1,5	8,9	16,8
	008	26,4 ml/rev	39,6	34,6	29,9	1,6	10,7	20,3
	010	34,1 ml/rev	51,1	46,1	41,4	1,7	13,4	25,6
	012	37,1 ml/rev	55,6	50,6	45,9	1,7	14,4	27,6
	014	46,0 ml/rev	69,0	64,0	59,3	1,9	17,6	33,7
	017	58,3 ml/rev	87,4	82,4	77,7	2,1	21,9	42,2
	020	63,8 ml/rev	95,7	90,7	86,0	2,2	23,8	46,0
	022	70,3 ml/rev	105,4	100,4	95,7	2,3	26,1	50,4
	025	79,3 ml/rev	118,9	113,9	109,2	2,5	29,2	56,6
028	88,8 ml/rev	133,2	128,2	125,8 ¹⁾	2,8	32,7	48,5 ¹⁾	
031	100,0 ml/rev	150,0	145,0	142,6 ¹⁾	2,8	36,5	54,4 ¹⁾	
			p = 0 bar	p = 140 bar	p = 300 bar	p = 7 bar	p = 140 bar	p = 300 bar
P2	B02	5,8 ml/rev	8,7	7,0	5,1	0,5	2,6	5,1
	B03	9,8 ml/rev	14,7	13,0	11,1	0,6	4,0	8,1
	B04	12,8 ml/rev	19,2	17,5	15,6	0,6	5,0	10,4
	B05	15,9 ml/rev	23,9	22,2	20,2	0,7	6,1	12,7
	B06	19,8 ml/rev	29,7	28,0	26,1	0,7	7,5	15,6
	B07	22,5 ml/rev	33,7	32,0	30,2	0,8	8,5	17,6
	B08	24,9 ml/rev	37,4	35,7	33,7	0,8	9,3	19,5
	B09	28,0 ml/rev	42,0	40,3	38,4	0,9	10,4	21,8
	B10	31,8 ml/rev	47,7	46,0	44,1	0,9	11,7	26,2
	B11	35,0 ml/rev	52,5	50,8	48,9	1,0	12,8	27,0
	B12	41,0 ml/rev	61,5	59,8	57,9	1,1	14,9	31,5
	B14	45,0 ml/rev	67,5	65,8	63,9	1,2	16,3	34,5
	B15	50,0 ml/rev	75,0	73,3	71,6 ²⁾	1,3	18,1	35,7 ²⁾

* We do not recommend to use the size 003 in P1 at 275 bar & 1500 RPM as the internal is over 50% of theoretical flow.

¹⁾ 028 - 031 = 210 bar max. int. ²⁾ B15 = 280 bar max.int.

Model No. T7DB or T7DBS - B42 - B10 - 1 R 00 - A 1 M1 - ..

T7DB series - 125 A2 HW
ISO 2 bolts 3019-2 mounting flange

T7DBS series - SAE C 2 bolts
J744 mounting flange

Displacement P1
Volumetric displacement (ml/rev.)
B14 = 44,0 B31 = 99,2
B17 = 55,0 B35 = 113,4
B20 = 66,0 B38 = 120,6
B22 = 70,3 B42 = 137,5
B24 = 81,1 045 = 145,7
B28 = 90,0 050 = 158,0

Displacement P2
Volumetric displacement (ml/rev.)
B02 = 5,8 B09 = 28,0
B03 = 9,8 B10 = 31,8
B04 = 12,8 B11 = 35,0
B05 = 15,9 B12 = 41,0
B06 = 19,8 B14 = 45,0
B07 = 22,5 B15 = 50,0
B08 = 24,9

Type of shaft T7DBS
1 = keyed (SAE C) 3 = splined (SAE C) 14 teeth
2 = keyed (non SAE) 4 = splined (spec. SAE C)

Type of shaft T7DB - T7DBS
5 = keyed (ISO 3019 -2 - G32 M)

Modifications

Mounting w/connection variables
4 bolts SAE flanges J518

	Metric thread T7DB - T7DBS		UNC thread T7DBS	
	M0	M1	00	01
P1	1.1/4"	1.1/4"	1.1/4"	1.1/4"
P2	1"	3/4"	1"	3/4"
S	3"	3"	3"	3"

Seal class
1 = S1 BUNA N - 0,7 bar max. (for mineral oil)
4 = S4 EPDM - 7 bar max. (for fire resistant fluids)
5 = S5 VITON® - 7 bar max. (for mineral oil and fire resistant fluids)

Design letter

Porting combination (see page 72)
00 = standard

Direction of rotation (shaft end view)
R = Clockwise
L = Counter-clockwise

INTERNAL LEAKAGE (TYPICAL)

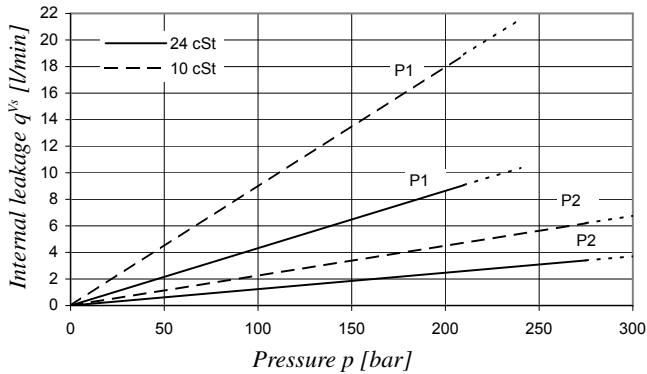

Do not operate pump more than 5 seconds at any speed or viscosity if internal leakage is higher than 50% of theoretical flow. Total leakage is the sum of each section loss under its respective operating conditions.

NOISE LEVEL (TYPICAL) - T7DBS - B31 - B10

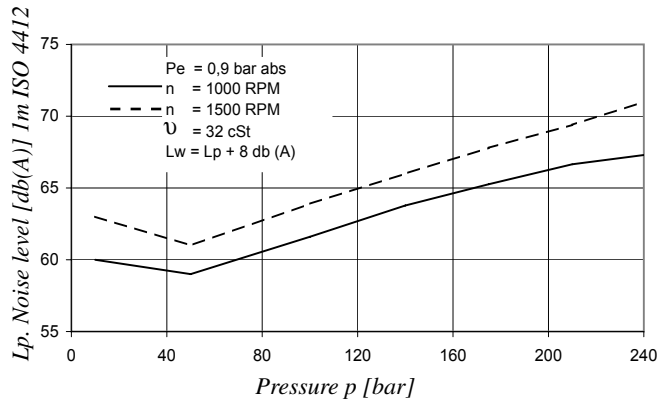

Double pump noise level is given with both stages discharging at the pressure value indicated on the curve.

POWER LOSS HYDROMECHANICAL (TYPICAL)

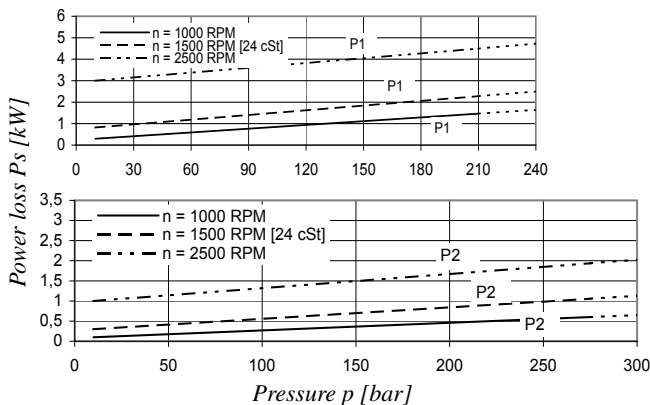

Total hydromechanical power loss is the sum of each section loss under its respective operating conditions.

PERMISSIBLE RADIAL LOAD

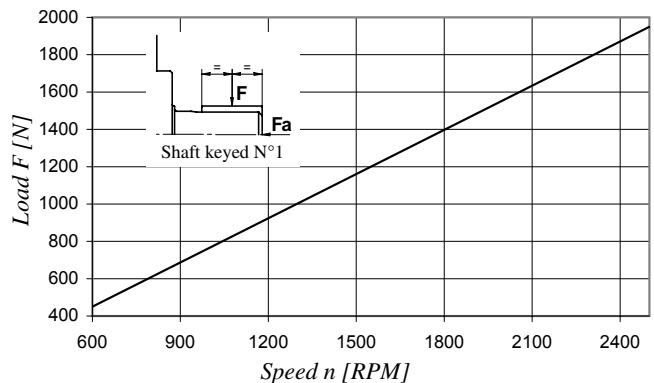

Maximum permissible axial load $F_a = 1200$ N

Model No. T67DC W - B42 - 010 - 1 R 00 - A 1 M1 - ..

Series - SAE C 2 bolts
 J744 mounting flange

Severe duty shaft option

Displacement P1
 Volumetric displacement (ml/rev.)
 B14 = 44,0 B31 = 99,2
 B17 = 55,0 B35 = 113,4
 B20 = 66,0 B38 = 120,6
 B22 = 70,3 B42 = 137,5
 B24 = 81,1 045 = 145,7
 B28 = 90,0 050 = 158,0

Displacement P2
 Volumetric displacement (ml/rev.)
 003 = 10,8 017 = 58,3
 005 = 17,2 020 = 63,8
 006 = 21,3 022 = 70,3
 008 = 26,4 025 = 79,3
 010 = 34,1 028 = 88,8
 012 = 37,1 031 = 100,0
 014 = 46,0

Type of shaft
 1 = keyed (SAE C) 3 = splined (SAE C) 14 teeth
 2 = keyed (non SAE) 4 = splined (spec. SAE C)

Type of shaft - Severe duty (T67DCW only)
 5 = keyed (non SAE)

Modifications

Mounting w/connection variables
 4 bolts SAE flanges J518

	Metric thread		UNC thread	
	M0	M1	00	01
P1	1.1/4"	1.1/4"	1.1/4"	1.1/4"
P2	1"	3/4"	1"	3/4"
S	3"	3"	3"	3"

Seal class
 1 = S1 BUNA N - 0,7 bar max. (for mineral oil)
 4 = S4 EPDM - 7 bar max. (for fire resistant fluids)
 5 = S5 VITON® - 7 bar max. (for mineral oil and fire resistant fluids)

Design letter

Porting combination (see page 72)
 00 = standard

Direction of rotation (shaft end view)
 R = Clockwise
 L = Counter-clockwise

INTERNAL LEAKAGE (TYPICAL)

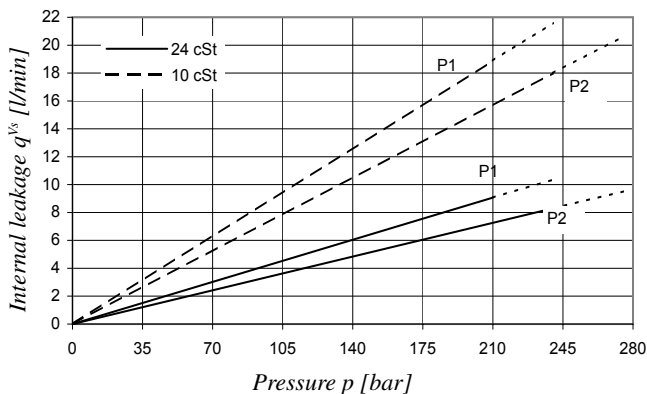

Do not operate pump more than 5 seconds at any speed or viscosity if internal leakage is higher than 50% of theoretical flow. Total leakage is the sum of each section loss under its respective operating conditions.

NOISE LEVEL (TYPICAL) - T67DC - B31 - 022

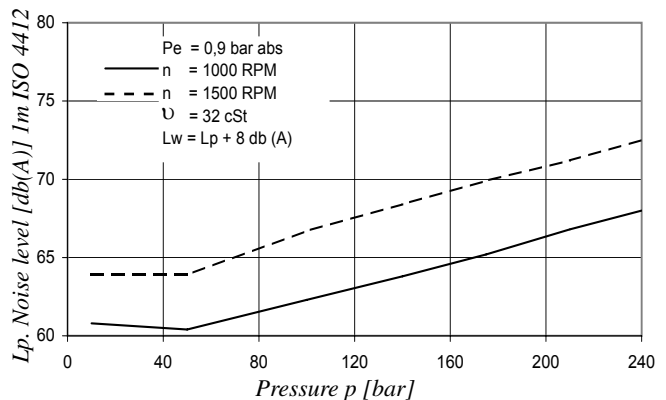

Double pump noise level is given with both stages section discharging at the pressure value indicated on the curve.

POWER LOSS HYDROMECHANICAL (TYPICAL)

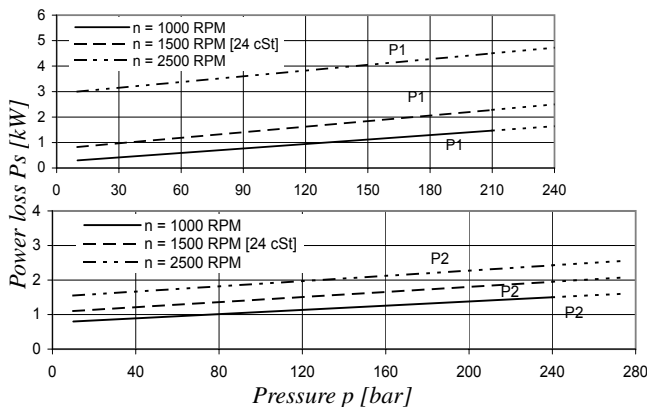

Total hydromechanical power loss is the sum of each section loss under its respective operating conditions.

PERMISSIBLE RADIAL LOAD

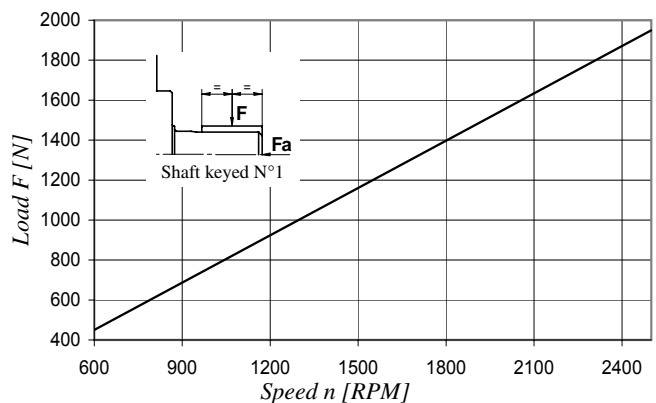

Maximum permissible axial load $F_a = 1200$ N

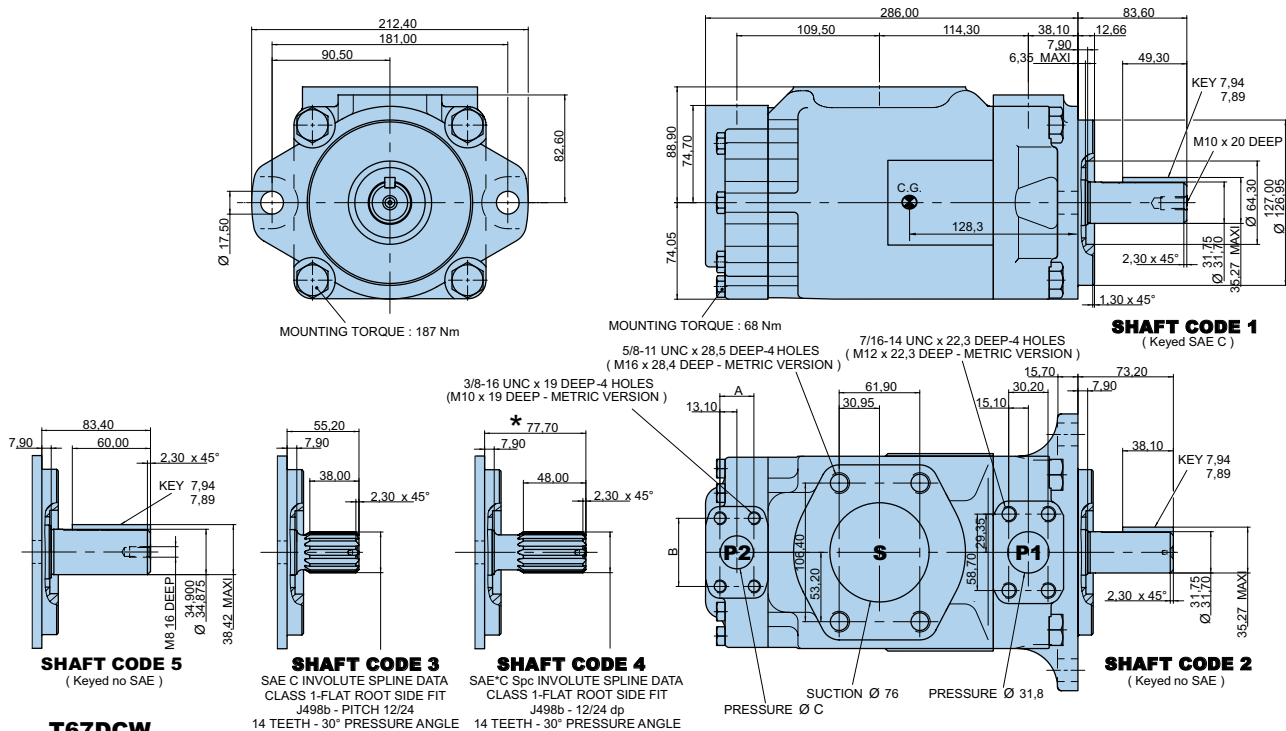

Alternate connect. variables		
	00 & M0	01 & M1
A	26,20	22,20
B	52,35	47,60
C	25,00	19,00

Shaft torque limits [ml/rev. x bar]			
Shaft	Vi x p max.	Shaft	Vi x p max.
1	43240	4	61200
2	34590	5	55600
3	61200		

OPERATING CHARACTERISTICS - TYPICAL [24 cSt]

Pressure port	Series	Vi Volumetric displacement	Flow q _v [l/min] & n = 1500 RPM			Input power P [kW] & n = 1500 RPM		
			p = 0 bar	p = 140 bar	p = 250 bar	p = 7 bar	p = 140 bar	p = 250 bar
P1	B14	44,0 ml/rev	66,0	59,4	54,2	1,5	16,6	29,0
	B17	55,0 ml/rev	82,5	75,9	70,7	1,7	20,4	35,8
	B20	66,0 ml/rev	99,0	92,4	87,2	1,9	24,3	42,7
	B22	70,3 ml/rev	105,5	98,8	93,7	2,0	25,8	45,4
	B24	81,1 ml/rev	121,7	115,0	109,9	2,2	29,5	52,1
	B28	90,0 ml/rev	135,0	128,4	123,2	2,3	32,7	57,7
	B31	99,2 ml/rev	148,8	142,2	137,0	2,5	35,9	63,5
	B35	113,4 ml/rev	170,1	163,5	158,3	2,7	40,8	72,3
	B38	120,6 ml/rev	180,9	174,3	169,1	2,9	43,4	76,8
	B42	137,5 ml/rev	206,3	199,6	194,5	3,2	49,3	87,4
	045	145,7 ml/rev	218,6	209,2	202,6 ²⁾	4,1	52,8	89,5 ²⁾
	050	158,0 ml/rev	237,0	227,7	223,0 ¹⁾	4,4	57,1	85,0 ¹⁾
			p = 0 bar	p = 140 bar	p = 275 bar	p = 7 bar	p = 140 bar	p = 275 bar
P2	003	10,8 ml/rev	16,2	11,2	*	1,3	5,3	*
	005	17,2 ml/rev	25,8	20,8	16,1	1,4	7,5	13,9
	006	21,3 ml/rev	31,9	26,9	22,2	1,5	8,9	16,8
	008	26,4 ml/rev	39,6	34,6	29,9	1,6	10,7	20,3
	010	34,1 ml/rev	51,1	46,1	41,4	1,7	13,4	25,6
	012	37,1 ml/rev	55,6	50,6	45,9	1,7	14,4	27,6
	014	46,0 ml/rev	69,0	64,0	59,3	1,9	17,6	33,7
	017	58,3 ml/rev	87,4	82,4	77,7	2,1	21,9	42,2
	020	63,8 ml/rev	95,7	90,7	86,0	2,2	23,8	46,0
	022	70,3 ml/rev	105,4	100,4	95,7	2,3	26,1	50,4
	025	79,3 ml/rev	118,9	113,9	109,2	2,5	29,2	56,6
	028	88,8 ml/rev	133,2	128,2	125,8 ¹⁾	2,8	32,7	48,5 ¹⁾
	031	100,0 ml/rev	150,0	145,0	142,6 ¹⁾	2,8	36,5	54,4 ¹⁾

* We do not recommend to use the size 003 in P2 at 275 bar & 1500 RPM as the internal leakage is over 50% of theoretical flow.

¹⁾ 050 - 028 - 031 = 210 bar max. int. ²⁾ 045 = 240 bar max. int.

Model No. **T7DD or T7DDS - B42 - B22 - 1 R 00 - A 1 M0 - ..**

T7DD series - ISO 6 bolts 3019-2

Mounting flange 125-A2-HW or 125-B4 HW

T7DDS series - SAE C 6 bolts

J744 mounting flange

Displacement P1 & P2

Volumetric displacement (ml/rev.)

B14 = 44,0 B31 = 99,2

B17 = 55,0 B35 = 113,4

B20 = 66,0 B38 = 120,6

B22 = 70,3 B42 = 137,5

B24 = 81,1 045 = 145,7

B28 = 90,0 050 = 158,0

Type of shaft T7DDS

1 = keyed (SAE C)

3 = splined (SAE C) 14 teeth

2 = keyed (SAE CC)

4 = splined (SAE BB)

Type of shaft - T7DD and T7DDS

5 = keyed (ISO 3019-2 - G32M)

Modifications

Mounting w/connection variables

4 bolts SAE flanges J518

P1 & P2 = 1.1/4" - S = 4"		
Type	Metric thread	UNC thread
T7DD	M0	
T7DDS	M0	00

Seal class

1 = S1 BUNA N - 0,7 bar max. (for mineral oil)

4 = S4 EPDM - 7 bar max. (for fire resistant fluids)

5 = S5 VITON® - 7 bar max. (for mineral oil and fire resistant fluids)

Design letter

Porting combination (see page 72)

00 = standard

Direction of rotation (shaft end view)

R = Clockwise

L = Counter-clockwise

INTERNAL LEAKAGE (TYPICAL)

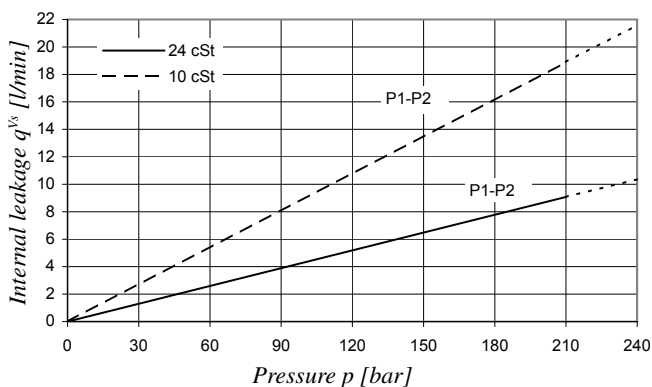

Do not operate pump more than 5 seconds at any speed or viscosity if internal leakage is higher than 50% of theoretical flow.

Total leakage is the sum of each section loss under its respective operating conditions.

NOISE LEVEL (TYPICAL) - T7DDS - B31 - B31

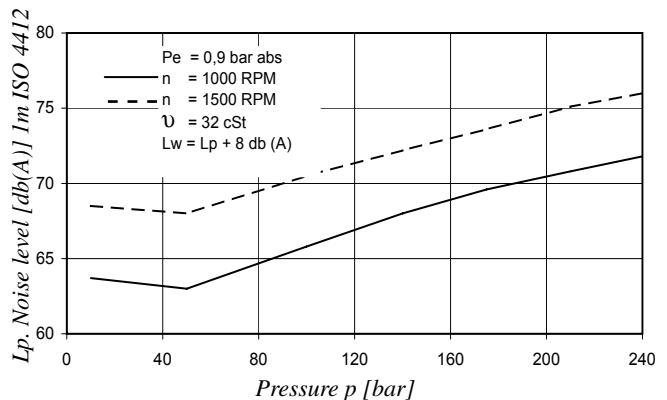

Double pump noise level is given with both stages discharging at the pressure value indicated on the curve.

POWER LOSS HYDROMECHANICAL (TYPICAL)

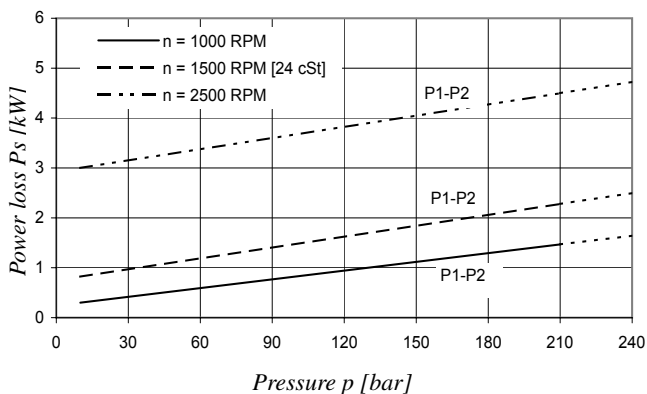

Total hydromechanical power loss is the sum of each section loss under its respective operating conditions.

PERMISSIBLE RADIAL LOAD

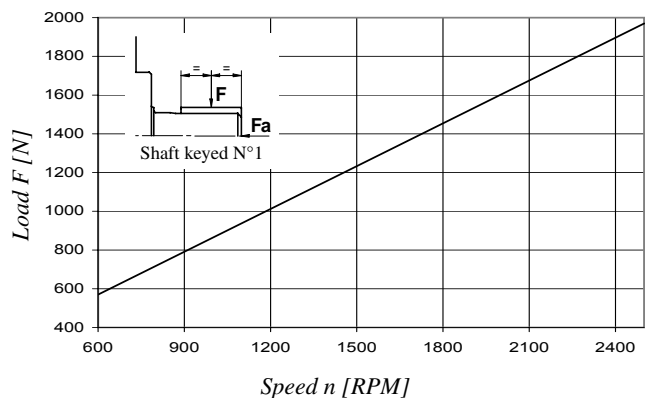

Maximum permissible axial load Fa = 1200 N

Model No. T7EB or T7EBS - 042 - B12 - 1 R 00 - A 1 M1 - ..

T7EB series - ISO 2 bolts 3019-2
 Mounting flange 125-A2 HW
T7EBS series - SAE C 2 bolts
 J744 mounting flange

Displacement P1
 Volumetric displacement (ml/rev.)
 042 = 132,3 057 = 183,3
 045 = 142,4 062 = 196,7
 050 = 158,5 066 = 213,3
 052 = 164,8 072 = 227,1
 054 = 171,0 085 = 268,7

Displacement P2
 Volumetric displacement (ml/rev.)
 B02 = 5,8 B09 = 28,0
 B03 = 9,8 B10 = 31,8
 B04 = 12,8 B11 = 35,0
 B05 = 15,9 B12 = 41,0
 B06 = 19,8 B14 = 45,0
 B07 = 22,5 B15 = 50,0
 B08 = 24,9

Type of shaft T7EBS
 1 = keyed (SAE CC) 3 = splined (SAE C) 14 teeth
 2 = keyed (non SAE) 4 = splined (SAE CC)

Type of shaft T7EB - T7EBS
 5 = keyed (ISO /R 775 - G38 M)

Modifications

Mounting w/connection variables
 4 bolts SAE flanges J518

P1 = 1.1/2" - P2 = 3/4" - S = 3.1/2"		
	Metric thread T7EB - T7EBS	UNC thread T7EBS
Code	M1	01

Seal class
 1 = S1 BUNA N - 0,7 bar max. (for mineral oil)
 4 = S4 EPDM - 7 bar max. (for fire resistant fluids)
 5 = S5 VITON® - 7 bar max. (for mineral oil and fire resistant fluids)

Design letter

Porting combination (see page 72)
 00 = standard

Direction of rotation (shaft end view)
 R = Clockwise
 L = Counter-clockwise

INTERNAL LEAKAGE (TYPICAL)

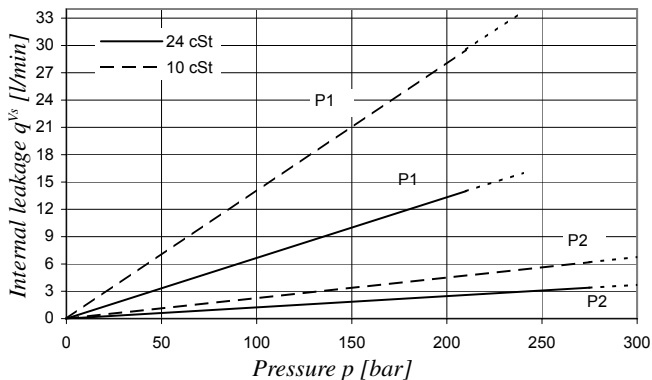

Do not operate pump more than 5 seconds at any speed or viscosity if internal leakage is higher than 50% of theoretical flow. Total leakage is the sum of each section loss under its respective operating conditions.

NOISE LEVEL (TYPICAL) - T7EBS - 050 - B03

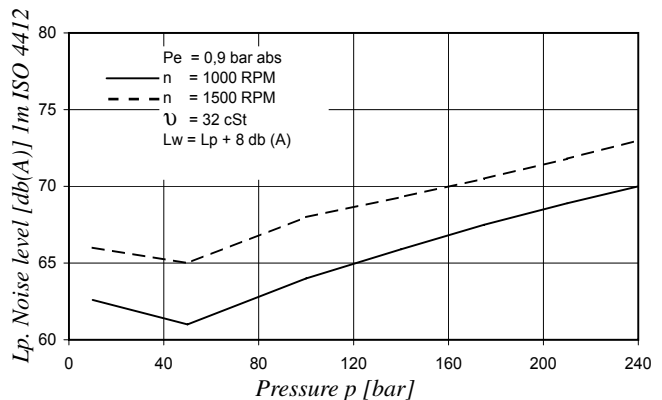

Double pump noise level is given with both stages discharging at the pressure value indicated on the curve.

POWER LOSS HYDROMECHANICAL (TYPICAL)

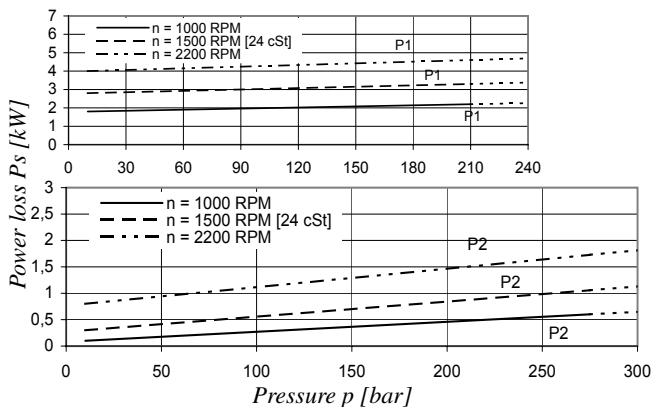

Total hydromechanical power loss is the sum of each section loss under its respective operating conditions.

PERMISSIBLE RADIAL LOAD

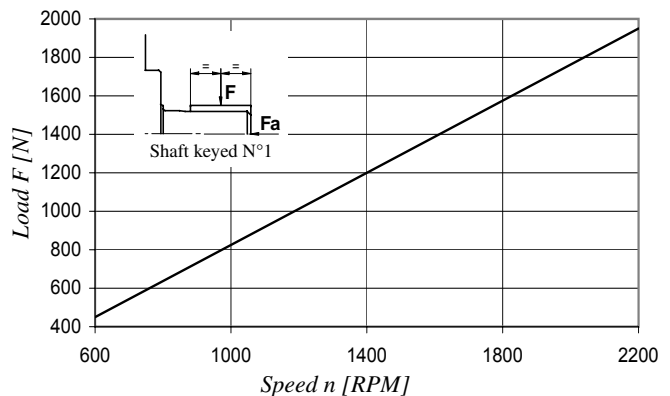

Maximum permissible axial load Fa = 2000 N

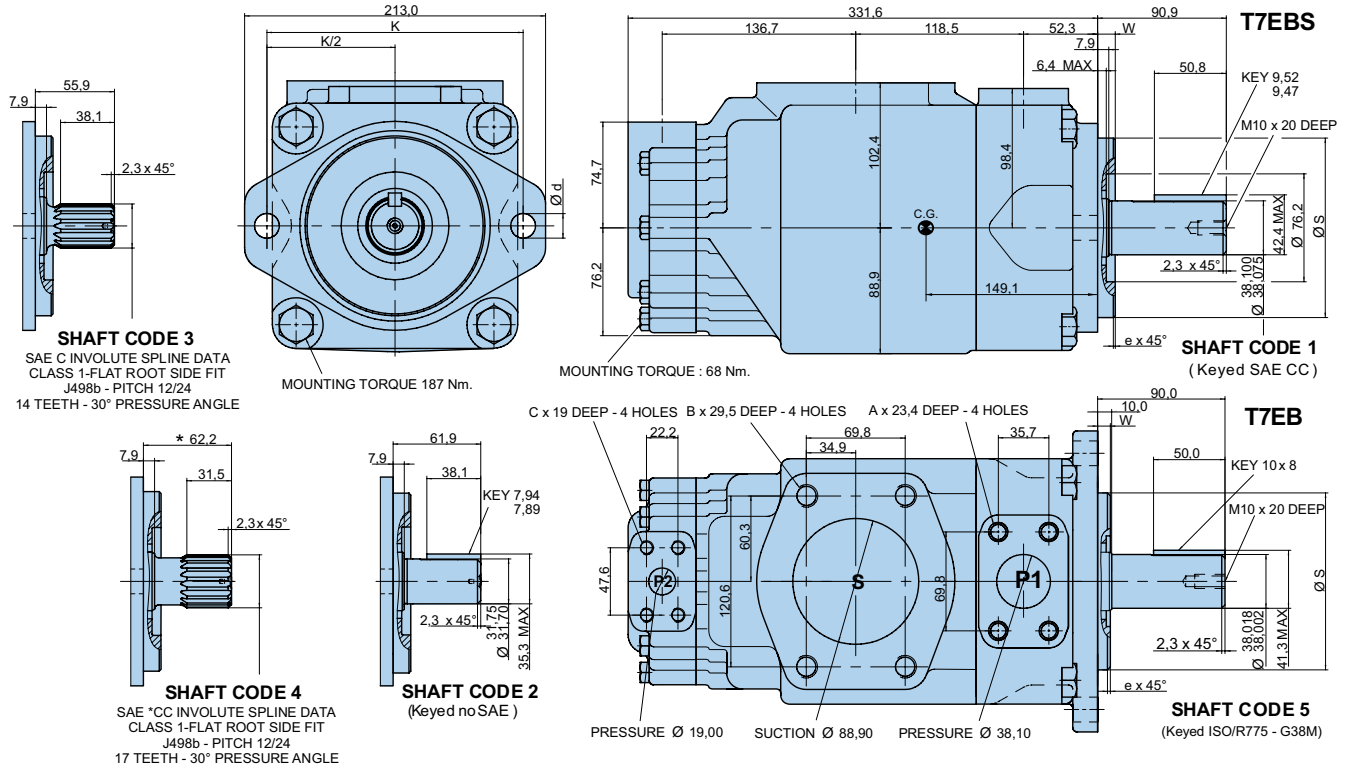

Alternate mounting flange						
	Dia S		e x 45°	W	K	Dia d
	Max.	Min.				
T7EB	125,000	124,937	2,0	9,5	180,0	18,0
T7EBS	127,000	126,950	1,3	12,7	181,0	17,5

Alternate connect. variables		
	01	M1
A	1/2" - 13 UNC	M12
B	5/8" - 11 UNC	M16
C	3/8" - 16 UNC	M10

Shaft torque limits [ml/rev. x bar]			
Shaft	Vi x p max.	Shaft	Vi x p max.
1	68500	4	68500
2	34590	5	68500
3	61200		

OPERATING CHARACTERISTICS - TYPICAL [24 cSt]

Pressure port	Series	Vi Volumetric displacement	Flow q _v [l/min] & n = 1500 RPM			Input power P [kW] & n = 1500 RPM		
			p = 0 bar	p = 140 bar	p = 240 bar	p = 7 bar	p = 140 bar	p = 240 bar
P1	042	132,3 ml/rev	198,5	188,5	181,3	5,2	49,4	82,6
	045	142,4 ml/rev	213,6	203,6	196,5	5,4	52,9	88,7
	050	158,5 ml/rev	237,7	227,7	220,6	5,7	58,5	98,3
	052	164,8 ml/rev	247,2	237,2	230,1	5,8	60,8	102,1
	054	171,0 ml/rev	256,5	246,5	239,4	5,9	63,0	105,8
	057	183,3 ml/rev	275,0	265,0	257,9	6,1	67,3	113,2
	062	196,7 ml/rev	295,0	285,0	277,9	6,4	71,9	121,3
	066	213,3 ml/rev	319,9	309,0	302,8	6,7	77,7	131,2
	072	227,1 ml/rev	340,6	330,6	323,5	6,9	82,6	139,5
	085	268,7 ml/rev	403,0	392,0 ¹⁾	-	9,1	65,8 ¹⁾	-
P2			p = 0 bar	p = 140 bar	p = 300 bar	p = 7 bar	p = 140 bar	p = 300 bar
	B02	5,8 ml/rev	8,7	7,0	5,1	0,5	2,6	5,1
	B03	9,8 ml/rev	14,7	13,0	11,1	0,6	4,0	8,1
	B04	12,8 ml/rev	19,2	17,5	15,6	0,6	5,0	10,4
	B05	15,9 ml/rev	23,9	22,2	20,2	0,7	6,1	12,7
	B06	19,8 ml/rev	29,7	28,0	26,1	0,7	7,5	15,6
	B07	22,5 ml/rev	33,7	32,0	30,2	0,8	8,5	17,6
	B08	24,9 ml/rev	37,4	35,7	33,7	0,8	9,3	19,5
	B09	28,0 ml/rev	42,0	40,3	38,4	0,9	10,4	21,8
	B10	31,8 ml/rev	47,7	46,0	44,1	0,9	11,7	26,2
	B11	35,0 ml/rev	52,5	50,8	48,9	1,0	12,8	27,0
	B12	41,0 ml/rev	61,5	59,8	57,9	1,1	14,9	31,5
	B14	45,0 ml/rev	67,5	65,8	63,9	1,2	16,3	34,5
	B15	50,0 ml/rev	75,0	73,3	71,6 ²⁾	1,3	18,1	35,7 ²⁾

¹⁾ 085 = 90 bar max. int.

²⁾ B15 = 280 bar max. int.

Model No. T67EC - 085 - 020 - 1 R 00 - A 1 00 - ..

Series - SAE C 2 bolts
 J744 mounting flange

Displacement P1

Volumetric displacement (ml/rev.)

042 = 132,3 057 = 183,3
 045 = 142,4 062 = 196,7
 050 = 158,5 066 = 213,3
 052 = 164,8 072 = 227,1
 054 = 171,0 085 = 268,7

Displacement P2

Volumetric displacement (ml/rev.)

003 = 10,8 017 = 58,3
 005 = 17,2 020 = 63,8
 006 = 21,3 022 = 70,3
 008 = 26,4 025 = 79,3
 010 = 34,1 028 = 88,8
 012 = 37,1 031 = 100,0
 014 = 46,0

Type of shaft

1 = keyed (SAE CC)
 2 = keyed (non SAE)
 3 = splined (SAE C) 14 teeth
 4 = splined (SAE CC) 17 teeth

Modifications

Mounting w/connection variables

4 bolts SAE flanges J518

Code	Metric thread		UNC thread	
	M0	M1	00	01
P1	1.1/2"	1.1/2"	1.1/2"	1.1/2"
P2	1"	3/4"	1"	3/4"
S	3.1/2"	3.1/2"	3.1/2"	3.1/2"

Seal class

1 = S1 BUNA N - 0,7 bar max. (for mineral oil)
 4 = S4 EPDM - 7 bar max. (for fire resistant fluids)
 5 = S5 VITON® - 7 bar max. (for mineral oil and fire resistant fluids)

Design letter

Porting combination (see page 72)

00 = standard

Direction of rotation (shaft end view)

R = Clockwise
 L = Counter-clockwise

INTERNAL LEAKAGE (TYPICAL)

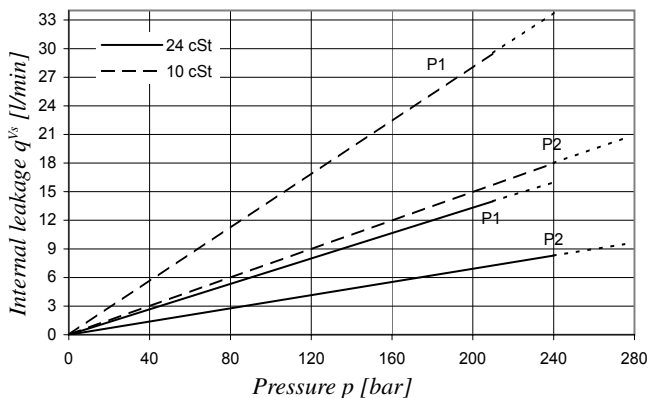

Do not operate pump more than 5 seconds at any speed or viscosity if internal leakage is higher than 50% of theoretical flow. Total leakage is the sum of each section loss under its respective operating conditions.

NOISE LEVEL (TYPICAL) - T67EC - 050 - 022

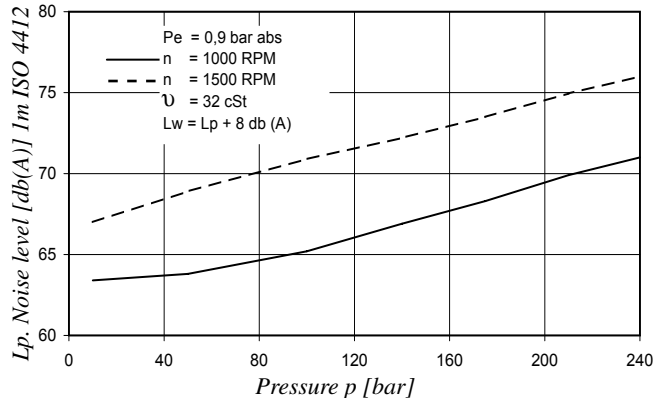

Double pump noise level is given with both stages discharging at the pressure value indicated on the curve.

POWER LOSS HYDROMECHANICAL (TYPICAL)

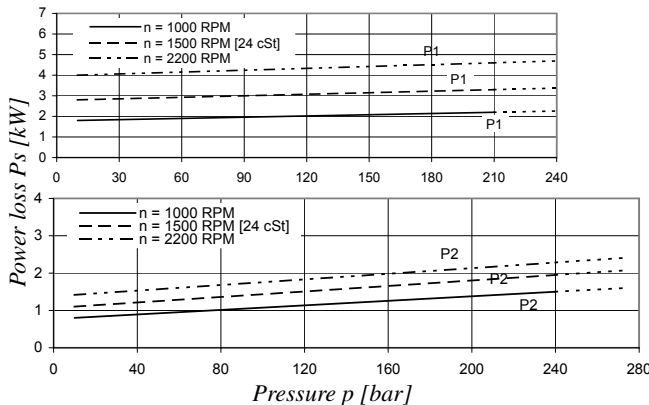

Total hydromechanical power loss is the sum of each section loss under its respective operating conditions.

PERMISSIBLE RADIAL LOAD

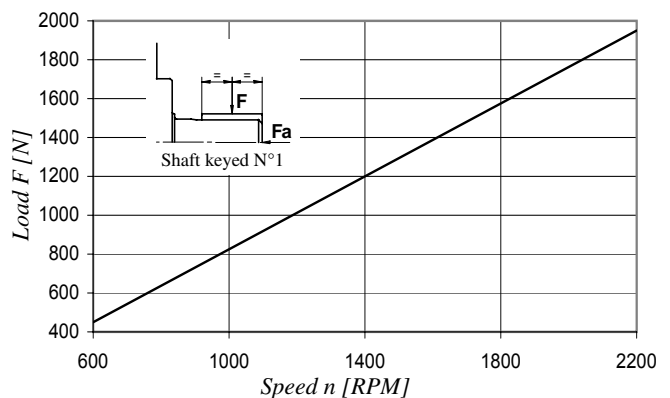

Maximum permissible axial load $F_a = 2000$ N

Model No. T7ED or T7EDS - 042 - B22 - 1 R 00 - A 1 M0 - ..

T7ED series - ISO 2 bolts 3019-2 mounting flange 125 A2 HW
T7EDS series - SAE C 2 bolts J744 mounting flange

Displacement P1
 Volumetric displacement (ml/rev.)
 042 = 132,3 057 = 183,3
 045 = 142,4 062 = 196,7
 050 = 158,5 066 = 213,3
 052 = 164,8 072 = 227,1
 054 = 171,0 085 = 268,7

Displacement P2
 Volumetric displacement (ml/rev.)
 B14 = 44,0 B31 = 99,2
 B17 = 55,0 B35 = 113,4
 B20 = 66,0 B38 = 120,6
 B22 = 70,3 B42 = 137,5
 B24 = 81,1 045 = 145,7
 B28 = 90,0 050 = 158,0

Type of shaft T7EDS
 1 = keyed (SAE CC) 3 = splined (SAE C) 14 teeth
 2 = keyed (non SAE) 4 = splined (SAE CC) 17 teeth

Type of shaft T7ED - T7EDS
 5 = keyed (ISO R775 - G38M)

Modifications

Mounting w/connection variables
 4 bolts SAE flanges J518

P1 = 1.1/2" - P2 = 1.1/4" - S = 4"		
	T7ED - T7EDS	T7EDS
Type	Metric thread	UNC thread
Code	M0	00

Seal class
 1 = S1 BUNA N - 0,7 bar max. (for mineral oil)
 4 = S4 EPDM - 7 bar max. (for fire resistant fluids)
 5 = S5 VITON® - 7 bar max. (for mineral oil and fire resistant fluids)

Design letter

Porting combination (see page 72)
 00 = standard

Direction of rotation (shaft end view)
 R = Clockwise
 L = Counter-clockwise

INTERNAL LEAKAGE (TYPICAL)

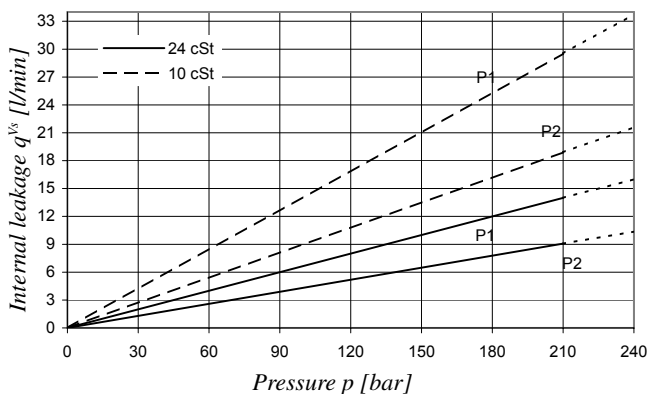

Do not operate pump more than 5 seconds at any speed or viscosity if internal leakage is higher than 50% of theoretical flow.
 Total leakage is the sum of each section loss under its respective operating conditions.

NOISE LEVEL (TYPICAL) - T7EDS - 050 - B31

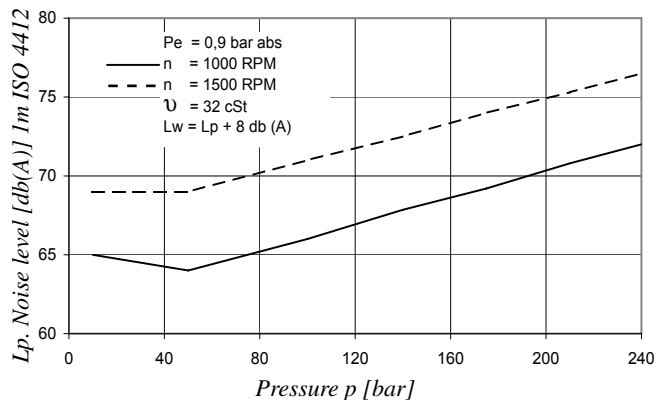

Double pump noise level is given with both stages discharging at the pressure value indicated on the curve.

POWER LOSS HYDROMECHANICAL (TYPICAL)

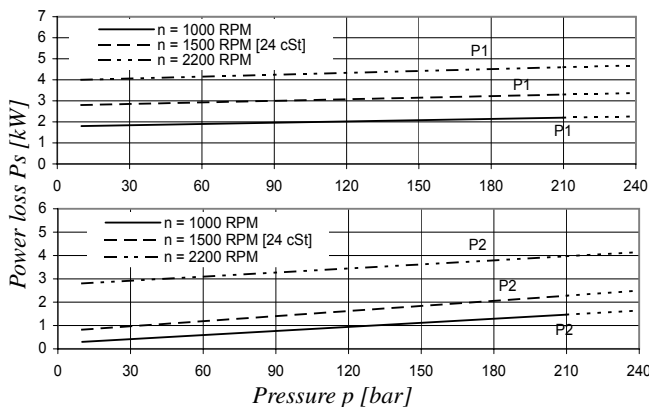

Total hydromechanical power loss is the sum of each section loss under its respective operating conditions.

PERMISSIBLE RADIAL LOAD

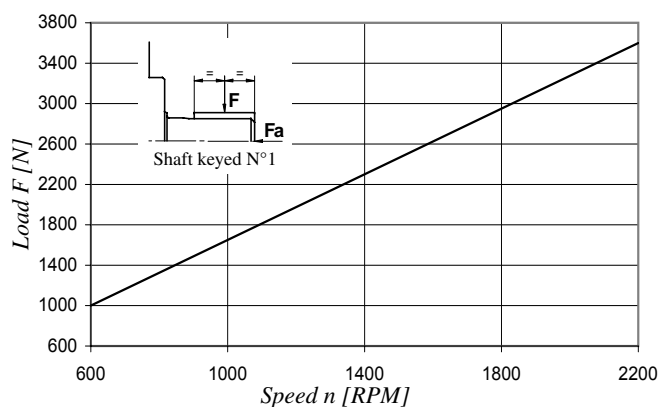

Maximum permissible axial load Fa = 2000 N

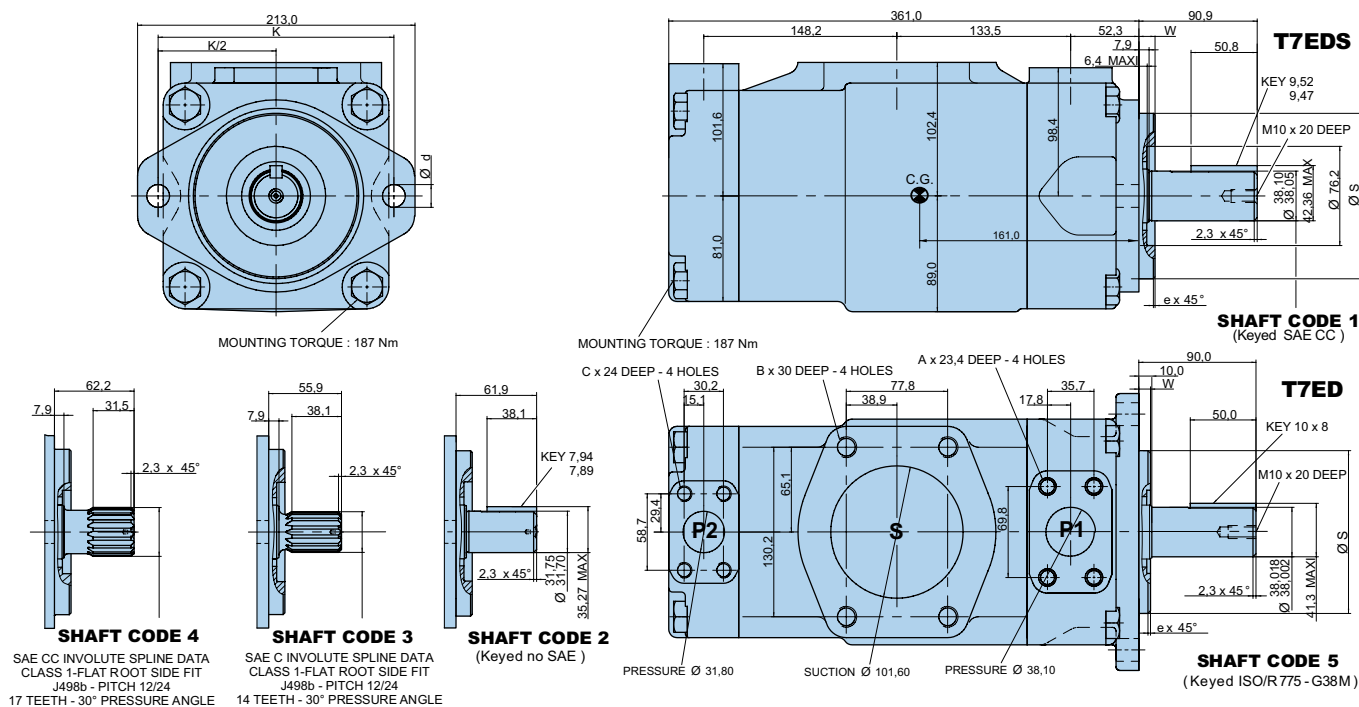

Alternate mounting flange						
	Dia S		e x 45°	W	K	Dia d
	Max.	Min.				
T7ED	125,000	124,937	2,0	9,5	180,0	18,0
T7EDS	127,000	126,950	1,3	12,7	181,0	17,5

Alternate connect. variables		
	00	M0
A	1/2" - 13 UNC	M12
B	5/8" - 11 UNC	M16
C	7/16" - 14 UNC	M12

Shaft torque limits [ml/rev. x bar]			
Shaft	Vi x p max.	Shaft	Vi x p max.
1	72300	4	68500
2	34590	5	68500
3	61200		

OPERATING CHARACTERISTICS - TYPICAL [24 cSt]

Pressure port	Series	Vi Volumetric displacement	Flow q _v [l/min] & n = 1500 RPM			Input power P [kW] & n = 1500 RPM		
			p = 0 bar	p = 140 bar	p = 240 bar	p = 7 bar	p = 140 bar	p = 240 bar
P1	042	132,3 ml/rev	198,5	188,5	181,3	5,2	49,4	82,6
	045	142,4 ml/rev	213,6	203,6	196,5	5,4	52,9	88,7
	050	158,5 ml/rev	237,7	227,7	220,6	5,7	58,5	98,3
	052	164,8 ml/rev	247,2	237,2	230,1	5,8	60,8	102,1
	054	171,0 ml/rev	256,5	246,5	239,4	5,9	63,0	105,8
	057	183,3 ml/rev	275,0	265,0	257,9	6,1	67,3	113,2
	062	196,7 ml/rev	295,0	285,0	277,9	6,4	71,9	121,3
	066	213,3 ml/rev	319,9	309,0	302,8	6,7	77,7	131,2
	072	227,1 ml/rev	340,6	330,6	323,5	6,9	82,6	139,5
	085	268,7 ml/rev	403,0	392,0 ¹⁾	-	9,1	65,8 ¹⁾	-
P2			p = 0 bar	p = 140 bar	p = 250 bar	p = 7 bar	p = 140 bar	p = 250 bar
	B14	44,0 ml/rev	66,0	59,4	54,2	1,5	16,6	29,0
	B17	55,0 ml/rev	82,5	75,9	70,7	1,7	20,4	35,8
	B20	66,0 ml/rev	99,0	92,4	87,2	1,9	24,3	42,7
	B22	70,3 ml/rev	105,5	98,8	93,7	2,0	25,8	45,4
	B24	81,1 ml/rev	121,7	115,0	109,9	2,2	29,5	52,1
	B28	90,0 ml/rev	135,0	128,4	123,2	2,3	32,7	57,7
	B31	99,2 ml/rev	148,8	142,2	137,0	2,5	35,9	63,5
	B35	113,4 ml/rev	170,1	163,5	158,3	2,7	40,8	72,3
	B38	120,6 ml/rev	180,9	174,3	169,1	2,9	43,4	76,8
	B42	137,5 ml/rev	206,3	199,6	194,5	3,2	49,3	87,4
	045	145,7 ml/rev	218,6	209,2	202,6 ³⁾	4,1	52,8	89,5 ³⁾
	050	158,0 ml/rev	237,0	227,7	223,0 ²⁾	4,4	57,1	85,0 ²⁾

¹⁾ 085 = 90 bar max. int. ²⁾ 050 = 210 bar max. int. ³⁾ 045 = 240 bar max. int.

Model No. T7EE or T7EES - 066 - 045 - 1 R 00 - A 1 0 00 - ..

T7EE series - ISO 4 bolts 3019-2

Mounting flange 250 B4 HW

T7EES series - SAE E 4 bolts

J744 mounting flange

P1 P2

Displacement P1 & P2

Volumetric displacement (ml/rev.)

042 = 132,3 057 = 183,3

045 = 142,4 062 = 196,7

050 = 158,5 066 = 213,3

052 = 164,8 072 = 227,1

054 = 171,0 085 = 268,7

Type of shaft T7EES

1 = keyed (SAE CC) 4 = splined (SAE D & E) 13 teeth

3 = splined (SAE CC) 17 teeth 5 = keyed (SAE D & E)

Type of shaft T7EE

2 = keyed (ISO 3019-2 - G45N)

Direction of rotation (shaft end view)

R = Clockwise

L = Counter-clockwise

Modifications

Mounting w/connection variables

4 bolts SAE flanges J518

P1 & P2 = 1.1/2" - S = 4"		
	T7EE - T7EES	T7EES
Type	Metric thread	UNC thread
Code	M0	00

Coupling adaptor

0 = none

2 = SAE B

3 = SAE BB

* for SAE C, please contact Parker

Seal class

1 = S1 BUNA N - 0,7 bar max. (for mineral oil)

4 = S4 EPDM - 7 bar max. (for fire resistant fluids)

5 = S5 VITON® - 7 bar max. (for mineral oil and fire resistant fluids)

Design letter

Porting combination (see page 72)

00 = standard

INTERNAL LEAKAGE (TYPICAL)

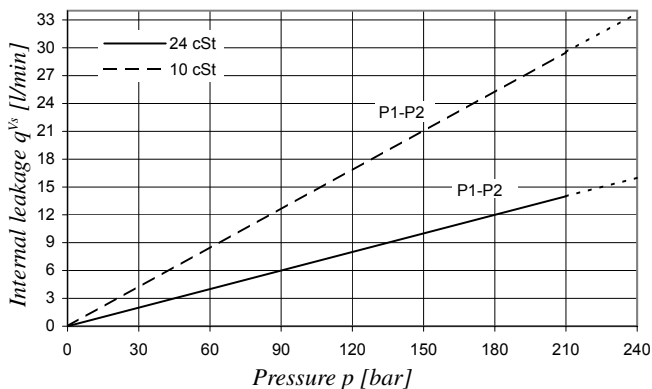

Do not operate pump more than 5 seconds at any speed or viscosity if internal leakage is higher than 50% of theoretical flow.

Total leakage is the sum of each section loss under its respective operating conditions.

NOISE LEVEL (TYPICAL) - T7EE - 050 - 050

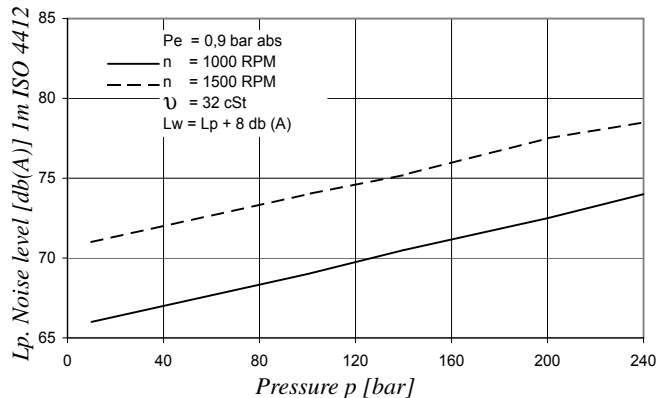

Double pump noise level is given with both stages discharging at the pressure value indicated on the curve.

POWER LOSS HYDROMECHANICAL (TYPICAL)

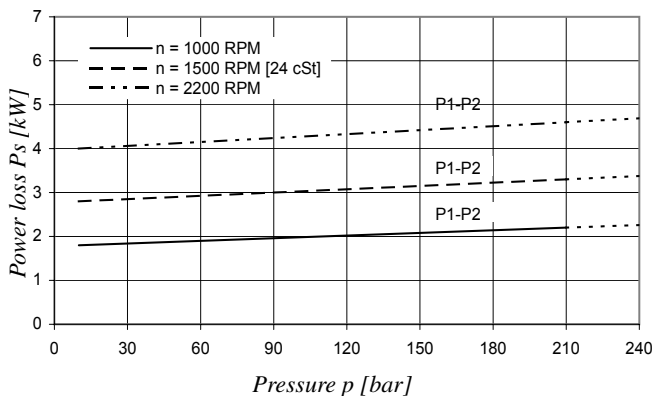

Total hydromechanical power loss is the sum of each section loss under its respective operating conditions.

PERMISSIBLE RADIAL LOAD

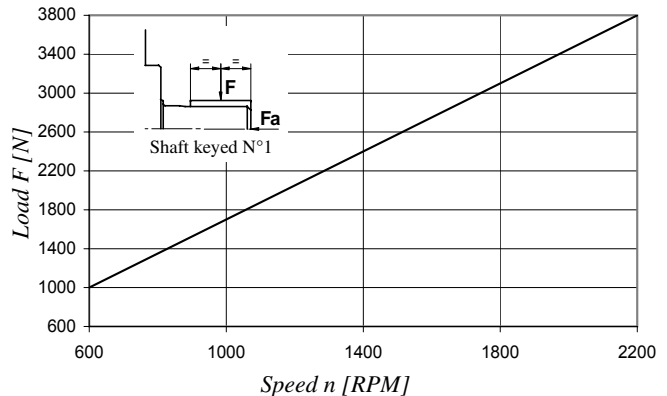

Maximum permissible axial load Fa = 2000 N

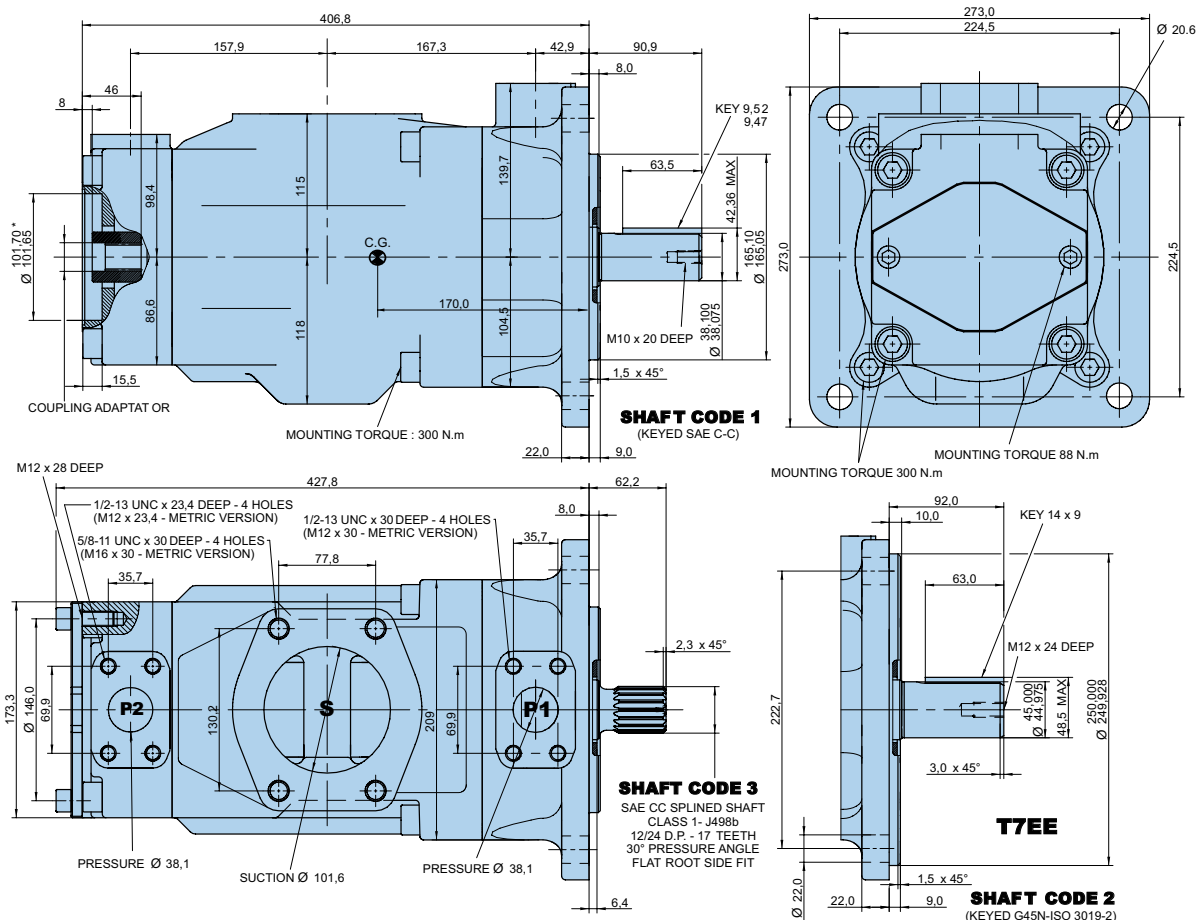

Code	Coupling adaptor
0	Without coupling
2	SAE B - 13 teeth - Pitch 16/32 Major dia. (min) 22,225 - Minor dia. (min) 19,134
3	SAE BB - 15 teeth - Pitch 16/32 Major dia. (min.) 25,400 - Minor dia. (min.) 22,268

Shaft torque limits [ml/rev. x bar]			
Shaft	Vi x p max.	Coupling drive	Vi x p max.
1	90380	SAE B	20600
2	114600	SAE BB	32670
3	126800		
4	126800		
5	118340		

OPERATING CHARACTERISTICS - TYPICAL [24 cSt]

Pressure port	Series	Vi Volumetric displacement	Flow q _v [l/min] & n = 1500 RPM			Input power P [kW] & n = 1500 RPM		
			p = 0 bar	p = 140 bar	p = 240 bar	p = 7 bar	p = 140 bar	p = 240 bar
P1 & P2	042	132,3 ml/rev	198,5	188,5	181,3	5,2	49,4	82,6
	045	142,4 ml/rev	213,6	203,6	196,5	5,4	52,9	88,7
	050	158,5 ml/rev	237,7	227,7	220,6	5,7	58,5	98,3
	052	164,8 ml/rev	247,2	237,2	230,1	5,8	60,8	102,1
	054	171,0 ml/rev	256,5	246,5	239,4	5,9	63,0	105,8
	057	183,3 ml/rev	275,0	265,0	257,9	6,1	67,3	113,2
	062	196,7 ml/rev	295,0	285,0	277,9	6,4	71,9	121,3
	066	213,3 ml/rev	319,9	309,0	302,8	6,7	77,7	131,2
	072	227,1 ml/rev	340,6	330,6	323,5	6,9	82,6	139,5
	085	268,7 ml/rev	403,0	392,0 ¹⁾	-	9,1	65,8 ¹⁾	-

¹⁾ 085 = 90 bar max. int.

* For SAE C, please contact Parker.

Model No. **T7DBB or T7DBBS - B38 - B14 - B08 - 1 R 00 - A 1 - M1 - ..**

T7DBB series - ISO 6 bolts 3019-2
Mounting flange 125-A2-HW or 125-B4-HW

T7DBBS series - SAE C 6 bolts
J744 mounting flange

Displacement for "P1"
Volumetric displacement (ml/rev)
B14 = 44,0 B31 = 99,2
B17 = 55,0 B35 = 113,4
B20 = 66,0 B38 = 120,6
B22 = 70,3 B42 = 137,5
B24 = 81,1 045 = 145,7
B28 = 90,0 050 = 158,0

Displacement for "P2" & "P3"
Volumetric displacement (ml/rev)
B02 = 5,8 B09 = 28,0
B03 = 9,8 B10 = 31,8
B04 = 12,8 B11 = 35,0
B05 = 15,9 B12 = 41,0
B06 = 19,8 B14 = 45,0
B07 = 22,5 B15 = 50,0
B08 = 24,9

Type of shaft T7DBBS
1 = keyed (non SAE)
2 = keyed (SAE CC)
3 = splined 12/24 (SAE C) (14 teeth)
4 = splined 12/24 (SAE CC) (17 teeth)

Type of shaft T7DBB & T7DBBS
5 = keyed (ISO 3019/2 - G38M)

Modifications

Mounting w/connection variables
4 bolts SAE flange J518

P1 = 1.1/4" - P2 = 1" - S = 4"		
	Metric thread	UNC thread
T7DBB-P3 = 3/4"	M1	
T7DBBS-P3 = 3/4"	M1	01
T7DBB-P3 = 1"	M0	
T7DBBS-P3 = 1"	M0	00

Seal class

1 = S1 BUNA N - 0,7 bar max. (for mineral oil)
4 = S4 EPDM - 7 bar max. (for fire resistant fluids)
5 = S5 VITON® - 7 bar max. (for mineral oil and fire resistant fluids)

Design letter

Porting combination (see pages 72 - 73)
00 = standard

Direction of rotation (shaft end view)

R = Clockwise
L = Counter-clockwise

OPERATING CHARACTERISTICS - TYPICAL [24 cSt]

Pressure port	Series	Vi Volumetric displacement	Flow q _{vc} [l/min] & n = 1500 RPM			Input power P [kW] & n = 1500 RPM		
			p = 0 bar	p = 140 bar	p = 250 bar	p = 7 bar	p = 140 bar	p = 250 bar
P1	B14	44,0 ml/rev	66,0	59,4	54,2	1,5	16,6	29,0
	B17	55,0 ml/rev	82,5	75,9	70,7	1,7	20,4	35,8
	B20	66,0 ml/rev	99,0	92,4	87,2	1,9	24,3	42,7
	B22	70,3 ml/rev	105,5	98,8	93,7	2,0	25,8	45,4
	B24	81,1 ml/rev	121,7	115,0	109,9	2,2	29,5	52,1
	B28	90,0 ml/rev	135,0	128,4	123,2	2,3	32,7	57,7
	B31	99,2 ml/rev	148,8	142,2	137,0	2,5	35,9	63,5
	B35	113,4 ml/rev	170,1	163,5	158,3	2,7	40,8	72,3
	B38	120,6 ml/rev	180,9	174,3	169,1	2,9	43,4	76,8
	B42	137,5 ml/rev	206,3	199,6	194,5	3,2	49,3	87,4
	045	145,7 ml/rev	218,6	209,2	202,6 ¹⁾	4,1	52,8	89,5 ¹⁾
050	158,0 ml/rev	237,0	227,7	223,0 ²⁾	4,4	57,1	85,0 ²⁾	
			p = 0 bar	p = 140 bar	p = 300 bar	p = 7 bar	p = 140 bar	p = 300 bar
P2 & P3	B02	5,8 ml/rev	8,7	7,0	5,1	0,5	2,6	5,1
	B03	9,8 ml/rev	14,7	13,0	11,1	0,6	4,0	8,1
	B04	12,8 ml/rev	19,2	17,5	15,6	0,6	5,0	10,4
	B05	15,9 ml/rev	23,9	22,2	20,2	0,7	6,1	12,7
	B06	19,8 ml/rev	29,7	28,0	26,1	0,7	7,5	15,6
	B07	22,5 ml/rev	33,7	32,0	30,2	0,8	8,5	17,6
	B08	24,9 ml/rev	37,4	35,7	33,7	0,8	9,3	19,5
	B09	28,0 ml/rev	42,0	40,3	38,4	0,9	10,4	21,8
	B10	31,8 ml/rev	47,7	46,0	44,1	0,9	11,7	26,2
	B11	35,0 ml/rev	52,5	50,8	48,9	1,0	12,8	27,0
	B12	41,0 ml/rev	61,5	59,8	57,9	1,1	14,9	31,5
	B14	45,0 ml/rev	67,5	65,8	63,9	1,2	16,3	34,5
	B15	50,0 ml/rev	75,0	73,3	71,6 ³⁾	1,3	18,1	35,7 ³⁾

¹⁾ 045 = 240 bar max. int. ²⁾ 050 = 210 bar max. int. ³⁾ B15 = 280 bar max. int.

INTERNAL LEAKAGE (TYPICAL)

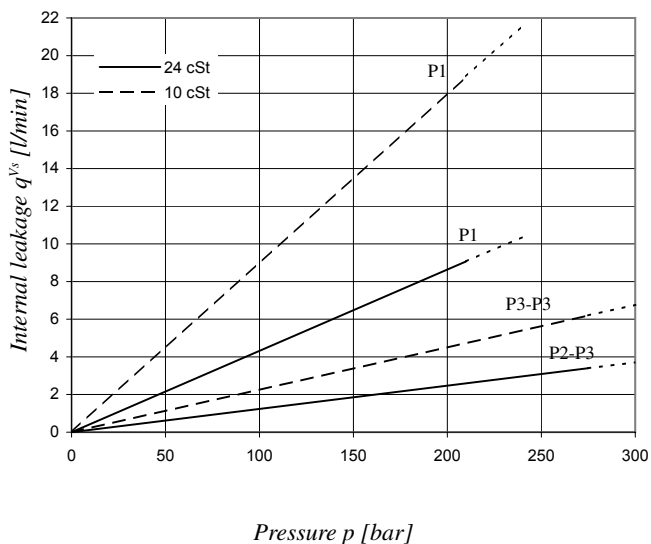

Do not operate pump more than 5 seconds at any speed or viscosity if internal leakage is higher than 50% of theoretical flow.
 Total leakage is the sum of each section loss under its respective operating conditions.

NOISE LEVEL (TYPICAL) - T7DBB - B38 - B06 - B04

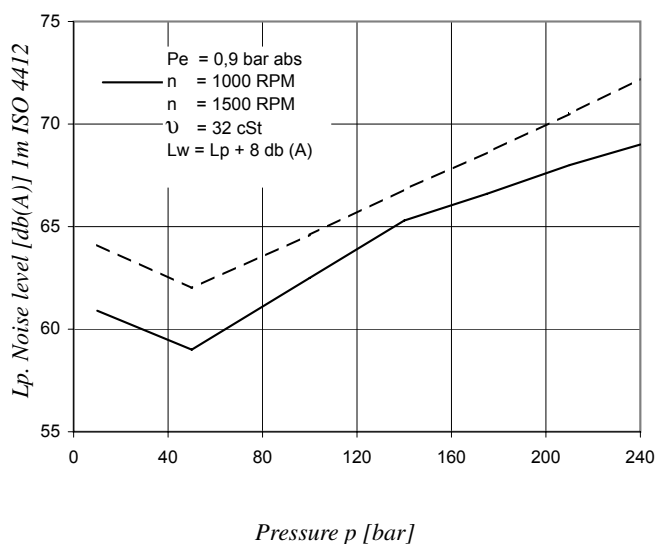

Triple pump noise level is given with all stages discharging at the pressure value indicated on the curve.

POWER LOSS HYDROMECHANICAL (TYPICAL)

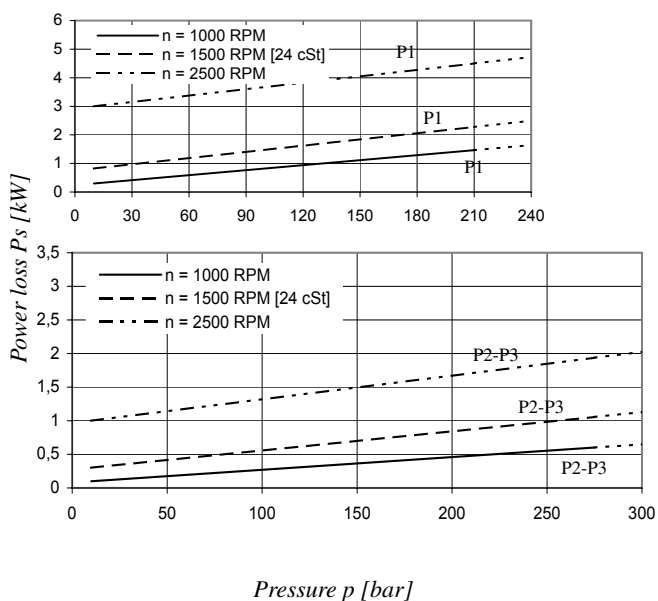

Total hydromechanical power loss is the sum of each section loss under its respective operating conditions.

PERMISSIBLE RADIAL LOAD

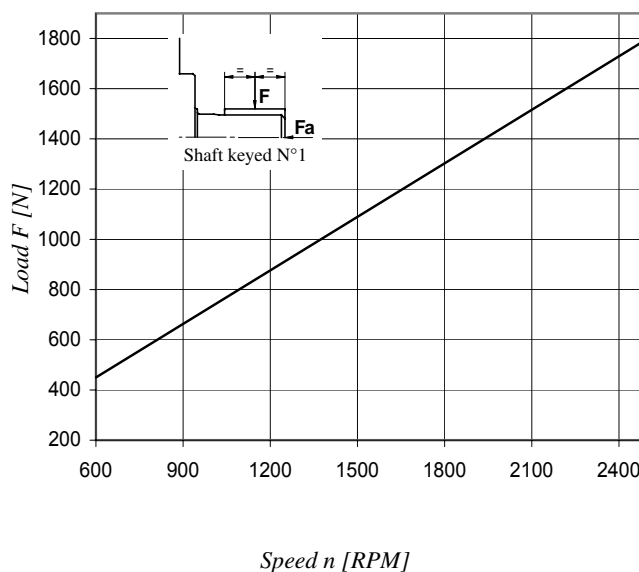

Maximum permissible axial load $F_a = 1200 \text{ N}$

Model No. T7DCB or T7DCBS - B38 - 028 - B08 - 1 R 00 - A 1 - M1 - ..

T7DCB series - ISO 6 bolts 3019-2
mounting flange 125-A2-HW or 125-B4-HW

T7DCBS series - SAE C 6 bolts
J744 mounting flange

Displacement for "P1"

Volumetric displacement (ml/rev)
B14 = 44,0 B24 = 81,1 B38 = 120,6
B17 = 55,0 B28 = 90,0 B42 = 137,5
B20 = 66,0 B31 = 99,2 045 = 145,7
B22 = 70,3 B35 = 113,4 050 = 158,0

Displacement for "P2"

Volumetric displacement (ml/rev)
003 = 10,8 012 = 37,1 022 = 70,3
005 = 17,2 014 = 46,0 025 = 79,3
006 = 21,3 017 = 58,3 028 = 88,8
008 = 26,4 020 = 63,8 031 = 100,0
010 = 34,1

Displacement for "P3"

Volumetric displacement (ml/rev)
B02 = 5,8 B07 = 22,5 B12 = 41,0
B03 = 9,8 B08 = 24,9 B14 = 45,0
B04 = 12,8 B09 = 28,0 B15 = 50,0
B05 = 15,9 B10 = 31,8
B06 = 19,8 B11 = 35,0

Modifications

Mounting w/connection variables
4 bolts SAE flange J518

	P1 = 1,1/4" - P2 = 1" - S = 4"	
	Metric thread	UNC thread
T7DCB-P3 = 3/4"	M1	
T7DCBS-P3 = 3/4"	M1	01
T7DCB-P3 = 1"	M0	
T7DCBS-P3 = 1"	M0	00

Seal class

1 = S1 BUNA N - 0,7 bar max. (for mineral oil)
4 = S4 EPDM- 7 bar max. (for fire resistant fluids)
5 = S5 VITON - 7 bar max. (for mineral oil and fire resistant fluids)

Design letter

Porting combination (see pages 72 - 73)
00 = standard

Direction of rotation (shaft end view)

R = Clockwise L = Counter-clockwise

Type of shaft T7DCB & T7DCBS - Type of shaft T7DCBS

5 = keyed (ISO 3019/2 - G38M) 1 = keyed (non SAE)
2 = keyed (SAE CC)
3 = splined 12/24 (SAE C) (14 teeth)
4 = splined 12/24 (SAE CC) (17 teeth)

OPERATING CHARACTERISTICS - TYPICAL [24 cSt]

Pressure port	Series	Vi Volumetric displacement	Flow q _v [l/min] & n = 1500 RPM			Input power P [kW] & n = 1500 RPM			
			p = 0 bar	p = 140 bar	p = 250 bar	p = 7 bar	p = 140 bar	p = 250 bar	
P1	B14	44,0 ml/rev	66,0	59,4	54,2	1,5	16,6	29,0	
	B17	55,0 ml/rev	82,5	75,9	70,7	1,7	20,4	35,8	
	B20	66,0 ml/rev	99,0	92,4	87,2	1,9	24,3	42,7	
	B22	70,3 ml/rev	105,5	98,8	93,7	2,0	25,8	45,4	
	B24	81,1 ml/rev	121,7	115,0	109,9	2,2	29,5	52,1	
	B28	90,0 ml/rev	135,0	128,4	123,2	2,3	32,7	57,7	
	B31	99,2 ml/rev	148,8	142,2	137,0	2,5	35,9	63,5	
	B35	113,4 ml/rev	170,1	163,5	158,3	2,7	40,8	72,3	
	B38	120,6 ml/rev	180,9	174,3	169,1	2,9	43,4	76,8	
	B42	137,5 ml/rev	206,3	199,6	194,5	3,2	49,3	87,4	
	045	145,7 ml/rev	218,6	209,2	202,6 ²⁾	4,1	52,8	89,5 ²⁾	
	050	158,0 ml/rev	237,0	227,7	223,0 ¹⁾	4,4	57,1	85,0 ¹⁾	
P2			p = 0 bar	p = 140 bar	p = 275 bar	p = 7 bar	p = 140 bar	p = 275 bar	
		003	10,8 ml/rev	16,2	11,2	*	1,3	5,3	*
		005	17,2 ml/rev	25,8	20,8	16,1	1,4	7,5	13,9
		006	21,3 ml/rev	31,9	26,9	22,2	1,5	8,9	16,8
		008	26,4 ml/rev	39,6	34,6	29,9	1,6	10,7	20,3
		010	34,1 ml/rev	51,1	46,1	41,4	1,7	13,4	25,6
		012	37,1 ml/rev	55,6	50,6	45,9	1,7	14,4	27,6
		014	46,0 ml/rev	69,0	64,0	59,3	1,9	17,6	33,7
		017	58,3 ml/rev	87,4	82,4	77,7	2,1	21,9	42,2
		020	63,8 ml/rev	95,7	90,7	86,0	2,2	23,8	46,0
		022	70,3 ml/rev	105,4	100,4	95,7	2,3	26,1	50,4
		025	79,3 ml/rev	118,9	113,9	109,2	2,5	29,2	56,6
		028	88,8 ml/rev	133,2	128,2	125,8 ¹⁾	2,8	32,7	48,5 ¹⁾
	031	100,0 ml/rev	150,0	145,0	142,6 ¹⁾	2,8	36,5	54,4 ¹⁾	
P3			p = 0 bar	p = 140 bar	p = 300 bar	p = 7 bar	p = 140 bar	p = 300 bar	
		B02	5,8 ml/rev	8,7	7,0	5,1	0,5	2,6	5,1
		B03	9,8 ml/rev	14,7	13,0	11,1	0,6	4,0	8,1
		B04	12,8 ml/rev	19,2	17,5	15,6	0,6	5,0	10,4
		B05	15,9 ml/rev	23,9	22,2	20,2	0,7	6,1	12,7
		B06	19,8 ml/rev	29,7	28,0	26,1	0,7	7,5	15,6
		B07	22,5 ml/rev	33,7	32,0	30,2	0,8	8,5	17,6
		B08	24,9 ml/rev	37,4	35,7	33,7	0,8	9,3	19,5
		B09	28,0 ml/rev	42,0	40,3	38,4	0,9	10,4	21,8
		B10	31,8 ml/rev	47,7	46,0	44,1	0,9	11,7	26,2
		B11	35,0 ml/rev	52,5	50,8	48,9	1,0	12,8	27,0
		B12	41,0 ml/rev	61,5	59,8	57,9	1,1	14,9	31,5
		B14	45,0 ml/rev	67,5	65,8	63,9	1,2	16,3	34,5
		B15	50,0 ml/rev	75,0	73,3	71,6 ³⁾	1,3	18,1	35,7 ³⁾

* We do not recommend to use the size 003 in P2 at 275 bar & 1500 RPM as the internal leakage is over 50% of theoretical flow.

¹⁾ 050 - 028 - 031 = 210 bar max. int. ²⁾ 045 = 240 bar max. int. ³⁾ B15 = 280 bar max. int.



INTERNAL LEAKAGE (TYPICAL)

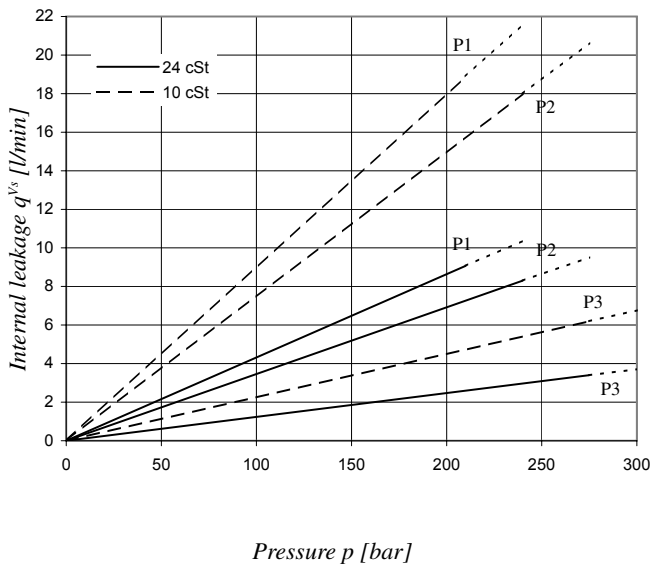

NOISE LEVEL (TYPICAL) - T7DCB - B38 - 022 - B10

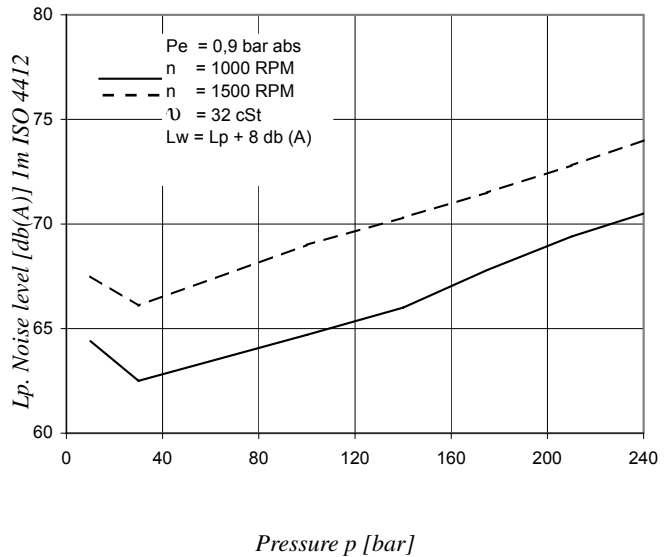

Do not operate pump more than 5 seconds at any speed or viscosity if internal leakage is higher than 50% of theoretical flow.
 Total leakage is the sum of each section loss under its respective operating conditions.

Triple pump noise level is given with all stages discharging at the pressure value indicated on the curve.

POWER LOSS HYDROMECHANICAL (TYPICAL)

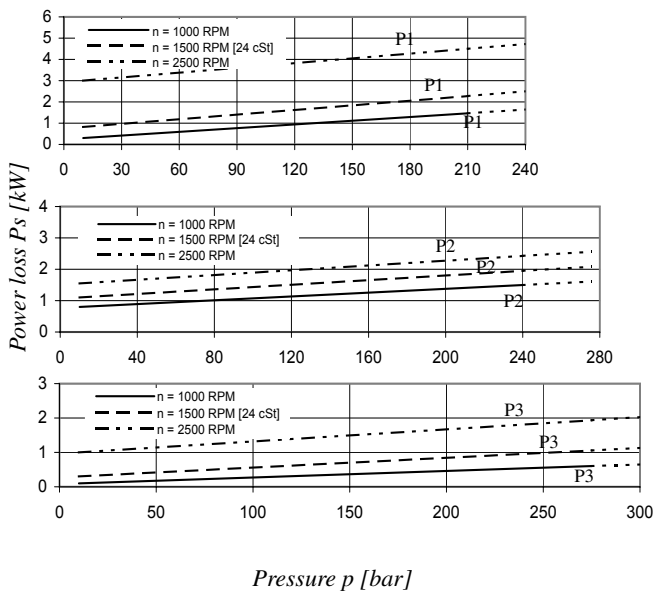

PERMISSIBLE RADIAL LOAD

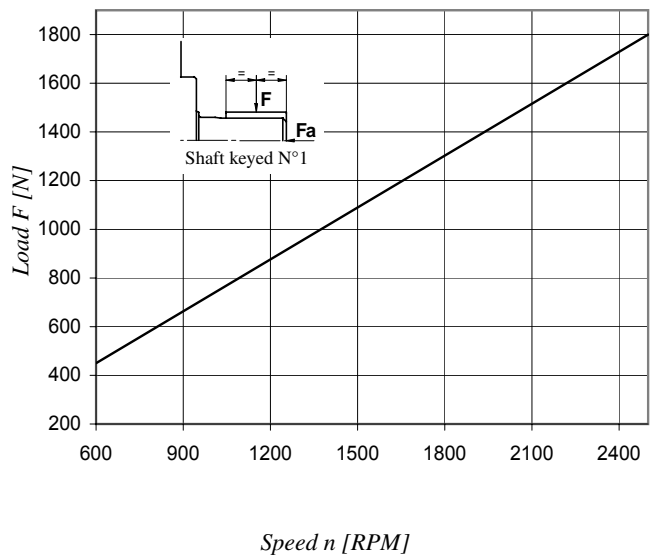

Total hydromechanical power loss is the sum of each section loss under its respective operating conditions.

Maximum permissible axial load $F_a = 800\text{ N}$

INTERNAL LEAKAGE (TYPICAL)

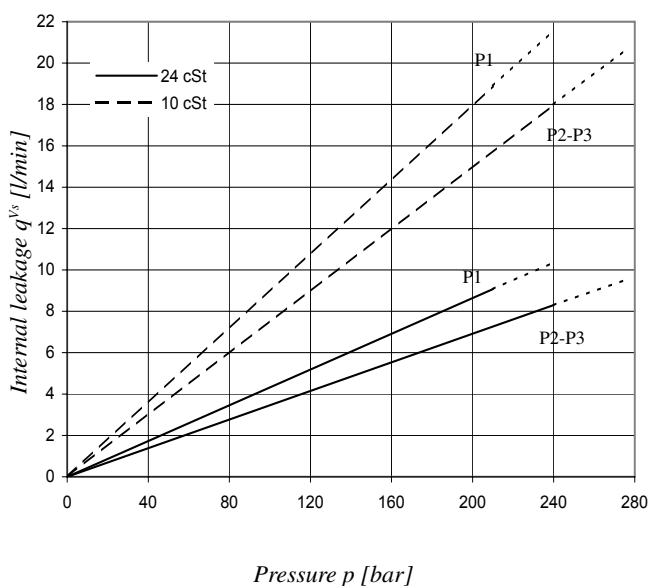

Do not operate pump more than 5 seconds at any speed or viscosity if internal leakage is higher than 50% of theoretical flow.
 Total leakage is the sum of each section loss under its respective operating conditions.

NOISE LEVEL (TYPICAL) - T7DCC - B31 - 022 - 022

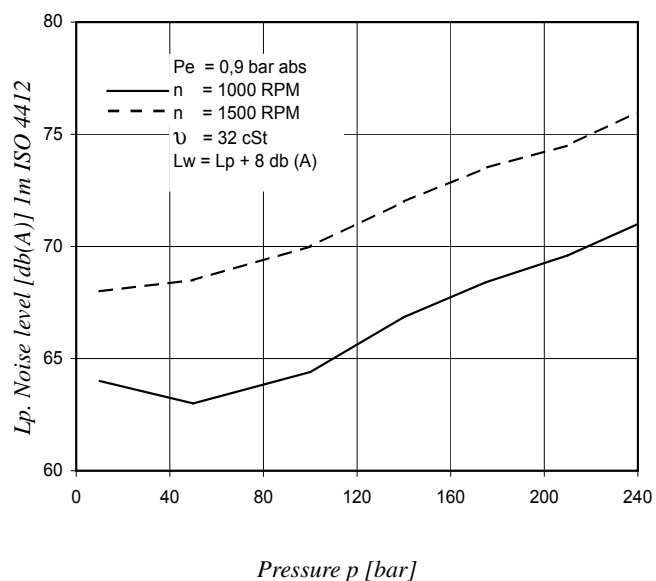

Triple pump noise level is given with all stages discharging at the pressure value indicated on the curve.

POWER LOSS HYDROMECHANICAL (TYPICAL)

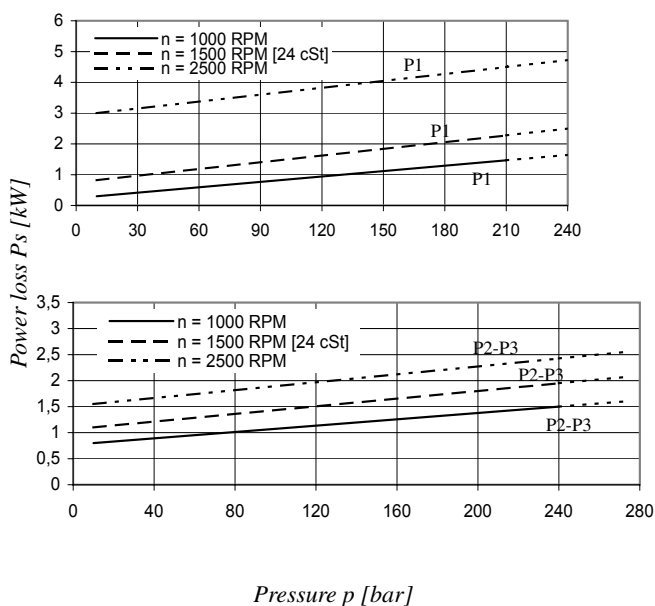

Total hydromechanical power loss is the sum of each section loss under its respective operating conditions.

PERMISSIBLE RADIAL LOAD

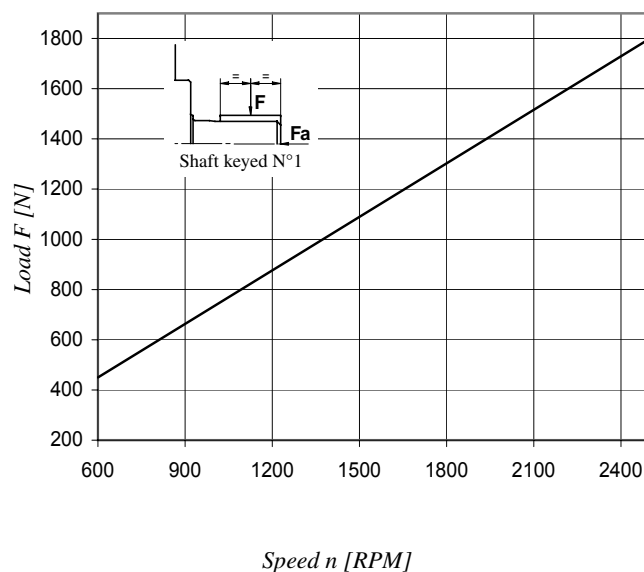

Maximum permissible axial load $F_a = 1200\text{ N}$

Model No. T7DCC or T7DCCS - B38 - 028 - 010 - 5 R 00 - A 1 - M0 - ..

T7DCC series - ISO 6 bolts 3019-2
Mounting flange 125-A2-HW or 125-B4-HW

T7DCCS series - SAE C 6 bolts
J744 mounting flange

Displacement for "P1"
Volumetric displacement (ml/rev)
B14 = 44,0 B31 = 99,2
B17 = 55,0 B35 = 113,4
B20 = 66,0 B38 = 120,6
B22 = 70,3 B42 = 137,5
B24 = 81,1 045 = 145,7
B28 = 90,0 050 = 158,0

Displacement for "P2" & P3
Volumetric displacement (ml/rev)
003 = 10,8 017 = 58,3
005 = 17,2 020 = 63,8
006 = 21,3 022 = 70,3
008 = 26,4 025 = 79,3
010 = 34,1 028 = 88,8
012 = 37,1 031 = 100,0
014 = 46,0

Type of shaft T7DCCS
1 = keyed (non SAE)
2 = keyed (SAE CC)
3 = splined 12/24 (SAE C)
4 = splined 12/24 (SAE CC)

Type of shaft T7DCC & T7DCCS
5 = keyed (ISO 3019/2 - G38M)

Modifications

Mounting w/connection variables
4 bolts SAE flange J518

P1 = 1.1/4" - P2 = 1" - S = 4"		
	Metric thread	UNC thread
T7DCC-P3 = 3/4"	M1	
T7DCCS-P3 = 3/4"	M1	01
T7DCC-P3 = 1"	M0	
T7DCCS-P3 = 1"	M0	00

Seal class
1 = S1 BUNA N - 0,7 bar max. (for mineral oil)
4 = S4 EPDM - 7 bar max. (for fire resistant fluids)
5 = S5 VITON® - 7 bar max. (for mineral oil and fire resistant fluids)

Design letter

Porting combination (see pages 72 - 73)
00 = standard

Direction of rotation (shaft end view)
R = Clockwise
L = Counter-clockwise

OPERATING CHARACTERISTICS - TYPICAL [24 cSt]

Pressure port	Series	Vi Volumetric displacement	Flow q _v [l/min] & n = 1500 RPM			Input power P [kW] & n = 1500 RPM		
			p = 0 bar	p = 140 bar	p = 250 bar	p = 7 bar	p = 140 bar	p = 250 bar
P1	B14	44,0 ml/rev	66,0	59,4	54,2	1,5	16,6	29,0
	B17	55,0 ml/rev	82,5	75,9	70,7	1,7	20,4	35,8
	B20	66,0 ml/rev	99,0	92,4	87,2	1,9	24,3	42,7
	B22	70,3 ml/rev	105,5	98,8	93,7	2,0	25,8	45,4
	B24	81,1 ml/rev	121,7	115,0	109,9	2,2	29,5	52,1
	B28	90,0 ml/rev	135,0	128,4	123,2	2,3	32,7	57,7
	B31	99,2 ml/rev	148,8	142,2	137,0	2,5	35,9	63,5
	B35	113,4 ml/rev	170,1	163,5	158,3	2,7	40,8	72,3
	B38	120,6 ml/rev	180,9	174,3	169,1	2,9	43,4	76,8
	B42	137,5 ml/rev	206,3	199,6	194,5	3,2	49,3	87,4
	045	145,7 ml/rev	218,6	209,2	202,6 ¹⁾	4,1	52,8	89,5 ¹⁾
	050	158,0 ml/rev	237,0	227,7	223,0 ²⁾	4,4	57,1	85,0 ²⁾
			p = 0 bar	p = 140 bar	p = 275 bar	p = 7 bar	p = 140 bar	p = 275 bar
P2 & P3	003	10,8 ml/rev	16,2	11,2	*	1,3	5,3	*
	005	17,2 ml/rev	25,8	20,8	16,1	1,4	7,5	13,9
	006	21,3 ml/rev	31,9	26,9	22,2	1,5	8,9	16,8
	008	26,4 ml/rev	39,6	34,6	29,9	1,6	10,7	20,3
	010	34,1 ml/rev	51,1	46,1	41,4	1,7	13,4	25,6
	012	37,1 ml/rev	55,6	50,6	45,9	1,7	14,4	27,6
	014	46,0 ml/rev	69,0	64,0	59,3	1,9	17,6	33,7
	017	58,3 ml/rev	87,4	82,4	77,7	2,1	21,9	42,2
	020	63,8 ml/rev	95,7	90,7	86,0	2,2	23,8	46,0
	022	70,3 ml/rev	105,4	100,4	95,7	2,3	26,1	50,4
	025	79,3 ml/rev	118,9	113,9	109,2	2,5	29,2	56,6
	028	88,8 ml/rev	133,2	128,2	125,8 ²⁾	2,8	32,7	48,5 ²⁾
	031	100,0 ml/rev	150,0	145,0	142,6 ²⁾	2,8	36,5	54,4 ²⁾

* We do not recommend to use the size 003 in P2 and P3 at 275 bar & 1500 RPM as the internal leakage is over 50% of theoretical flow.

¹⁾ 045 = 240 bar max. int. ²⁾ 050 - 028 - 031 = 210 bar max. int.

Model No. **T7DDB or T7DDBS - 050 - B22 - B12 - 1 R 00 - A 1 - M0 - ..**

T7DDB series - ISO 6 bolts 3019-2
Mounting flange 125-A2-HW

P1 P2 P3

T7DDBS series - SAE C 6 bolts
J744 mounting flange

Displacement for "P1" & "P2"
Volumetric displacement (ml/rev)
B14 = 44,0 B31 = 99,2
B17 = 55,0 B35 = 113,4
B20 = 66,0 B38 = 120,6
B22 = 70,3 B42 = 137,5
B24 = 81,1 045 = 145,7
B28 = 90,0 050 = 158,0

Displacement for "P3"
Volumetric displacement (ml/rev)
B02 = 5,8 B09 = 28,0
B03 = 9,8 B10 = 31,8
B04 = 12,8 B11 = 35,0
B05 = 15,9 B12 = 41,0
B06 = 19,8 B14 = 45,0
B07 = 22,5 B15 = 50,0
B08 = 24,9

Type of shaft T7DDBS
1 = keyed (SAE C)
2 = keyed (SAE CC)
3 = splined 12/24 (SAE C) (14 teeth)
4 = splined 12/24 (SAE CC) (17 teeth)

Type of shaft T7DDB & T7DDBS
5 = keyed (ISO 3019/2 - G38M)

Modifications

Mounting w/connection variables
4 bolts SAE flange J518

P1 & P2 = 1.1/4" - S = 4"		
	Metric thread	UNC thread
T7DDB-P3 = 1"	M0	
T7DDB-P3 = 3/4"	M1	
T7DDBS-P3 = 1"	M0	00
T7DDBS-P3 = 3/4"	M1	01

Seal class
1 = S1 BUNA N - 0,7 bar max. (for mineral oil)
4 = S4 EPDM - 7 bar max. (for fire resistant fluids)
5 = S5 VITON® - 7 bar max. (for mineral oil and fire resistant fluids)

Design letter

Porting combination (see pages 72 - 73)
00 = standard

Direction of rotation (shaft end view)
R = Clockwise
L = Counter-clockwise

OPERATING CHARACTERISTICS - TYPICAL [24 cSt]

Pressure port	Series	Vi Volumetric displacement	Flow q _v [l/min] & n = 1500 RPM			Input power P [kW] & n = 1500 RPM		
			p = 0 bar	p = 140 bar	p = 250 bar	p = 7 bar	p = 140 bar	p = 250 bar
P1 & P2	B14	44,0 ml/rev	66,0	59,4	54,2	1,5	16,6	29,0
	B17	55,0 ml/rev	82,5	75,9	70,7	1,7	20,4	35,8
	B20	66,0 ml/rev	99,0	92,4	87,2	1,9	24,3	42,7
	B22	70,3 ml/rev	105,5	98,8	93,7	2,0	25,8	45,4
	B24	81,1 ml/rev	121,7	115,0	109,9	2,2	29,5	52,1
	B28	90,0 ml/rev	135,0	128,4	123,2	2,3	32,7	57,7
	B31	99,2 ml/rev	148,8	142,2	137,0	2,5	35,9	63,5
	B35	113,4 ml/rev	170,1	163,5	158,3	2,7	40,8	72,3
	B38	120,6 ml/rev	180,9	174,3	169,1	2,9	43,4	76,8
	B42	137,5 ml/rev	206,3	199,6	194,5	3,2	49,3	87,4
	045	145,7 ml/rev	218,6	209,2	202,6 ¹⁾	4,1	52,8	89,5 ¹⁾
	050	158,0 ml/rev	237,0	227,7	223,0 ²⁾	4,4	57,1	85,0 ²⁾
			p = 0 bar	p = 140 bar	p = 300 bar	p = 7 bar	p = 140 bar	p = 300 bar
P3	B02	5,8 ml/rev	8,7	7,0	5,1	0,5	2,6	5,1
	B03	9,8 ml/rev	14,7	13,0	11,1	0,6	4,0	8,1
	B04	12,8 ml/rev	19,2	17,5	15,6	0,6	5,0	10,4
	B05	15,9 ml/rev	23,9	22,2	20,2	0,7	6,1	12,7
	B06	19,8 ml/rev	29,7	28,0	26,1	0,7	7,5	15,6
	B07	22,5 ml/rev	33,7	32,0	30,2	0,8	8,5	17,6
	B08	24,9 ml/rev	37,4	35,7	33,7	0,8	9,3	19,5
	B09	28,0 ml/rev	42,0	40,3	38,4	0,9	10,4	21,8
	B10	31,8 ml/rev	47,7	46,0	44,1	0,9	11,7	26,2
	B11	35,0 ml/rev	52,5	50,8	48,9	1,0	12,8	27,0
	B12	41,0 ml/rev	61,5	59,8	57,9	1,1	14,9	31,5
	B14	45,0 ml/rev	67,5	65,8	63,9	1,2	16,3	34,5
B15	50,0 ml/rev	75,0	73,3	71,6 ³⁾	1,3	18,1	35,7 ³⁾	

¹⁾ 045 = 240 bar max. int. ²⁾ 050 = 210 bar max. int. ³⁾ B15 = 280 bar max. int.

INTERNAL LEAKAGE (TYPICAL)

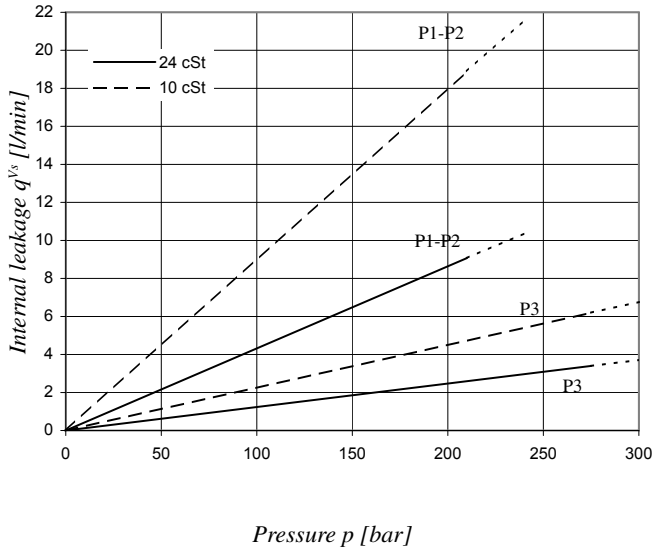

NOISE LEVEL (TYPICAL) - T7DDB - B31 - B31 - B10

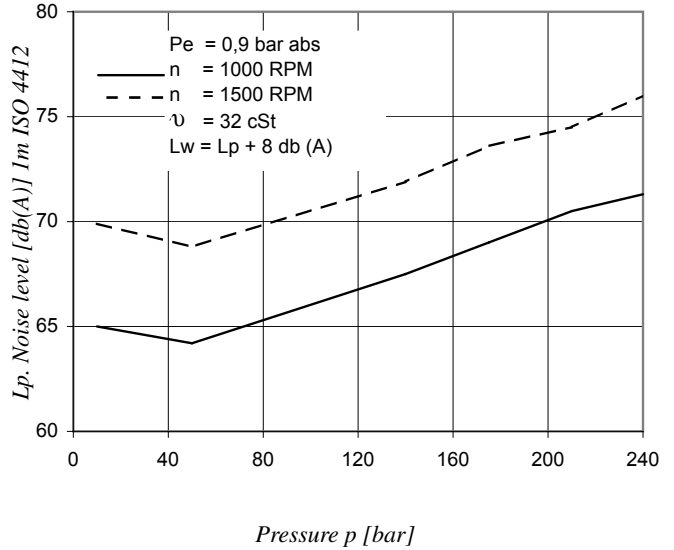

Do not operate pump more than 5 seconds at any speed or viscosity if internal leakage is higher than 50% of theoretical flow. Total leakage is the sum of each section loss under its respective operating conditions.

Triple pump noise level is given with all stages discharging at the pressure value indicated on the curve.

POWER LOSS HYDROMECHANICAL (TYPICAL)

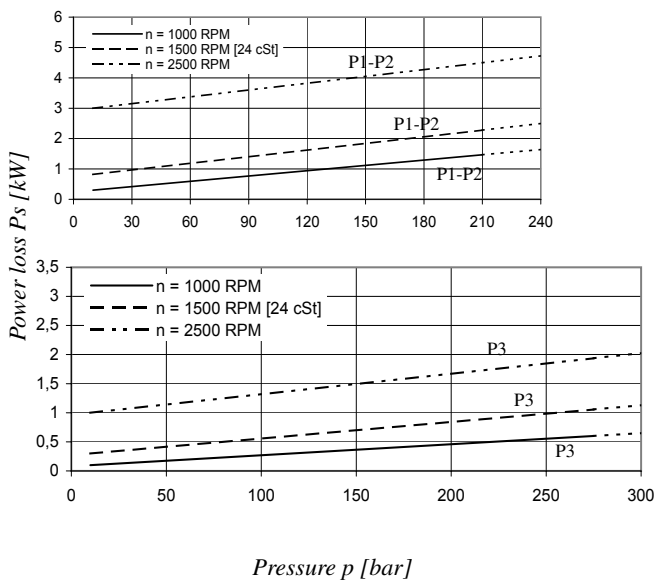

PERMISSIBLE RADIAL LOAD

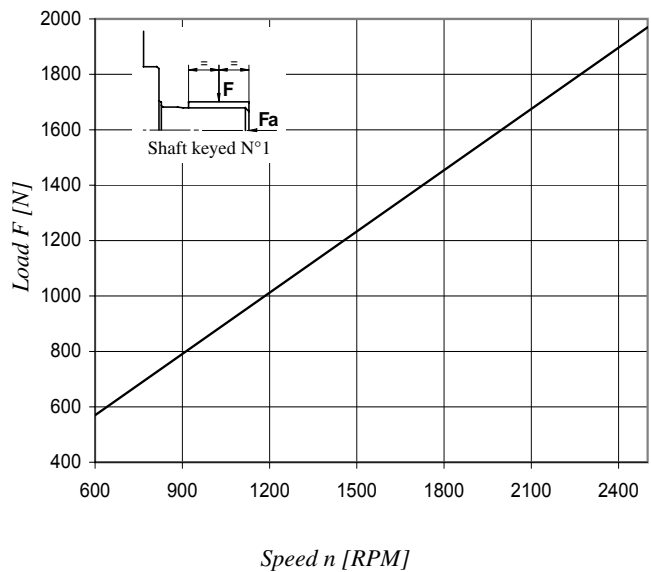

Total hydromechanical power loss is the sum of each section loss under its respective operating conditions.

Maximum permissible axial load $F_a = 1200\text{ N}$

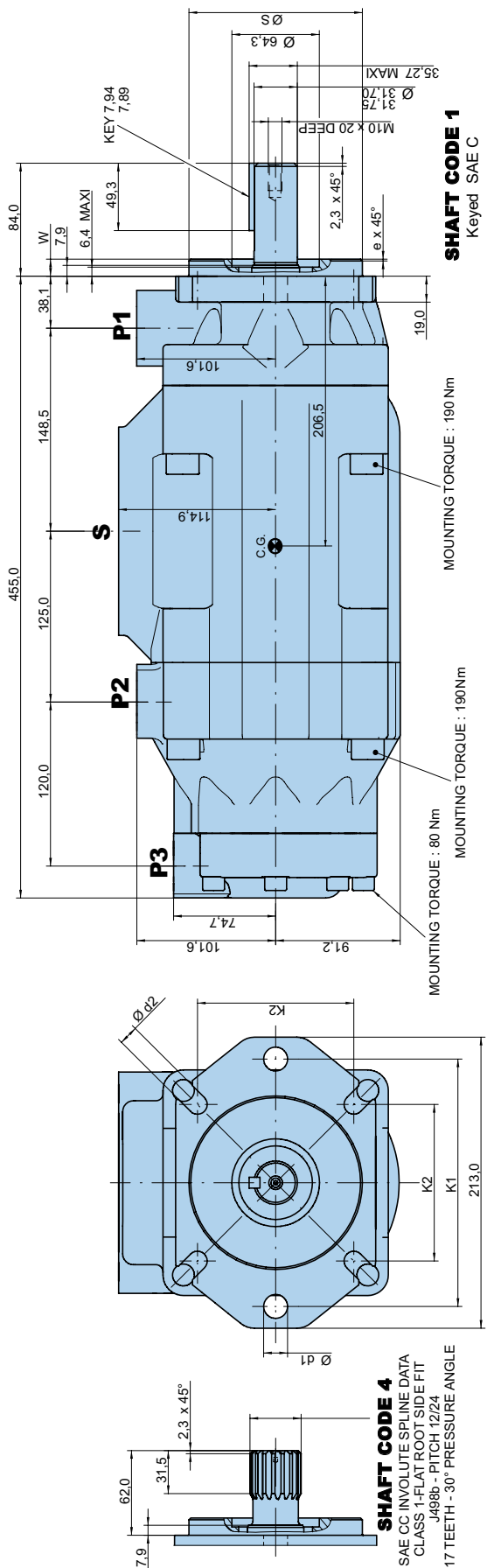

Alternate connect. variables	
00 & M0 01 & M1	
A	52,4
B	26,2
C	25,4
	47,6
	22,2
	19,0

Alternate mounting flange						
Series	Dia S		W	K1	K2	Dia d2
	Max.	Min.				
T7DDB	125,000	124,937	2,0	9,5	180,0	113,14
T7DDBS	127,000	126,950	1,5	12,7	181,0	114,50
				12,7	17,5	14,3

Shaft torque limits [ml/rev. x bar]		
Shaft Vi x p max. P1 + P2 + P3	Shaft Vi x p max. P1 + P2 + P3	Shaft Vi x p max. P1 + P2 + P3
1	43240	66500
2	72306	53100
3	61200	

Model No.

T67DDCS - 050 - B35 - B08 - 1 R 00 - A 1 - M0 - ..

Series - SAE C 6 bolts
J744 mounting flange

P1 P2 P3

Displacement for "P1" & "P2"

Volumetric displacement (ml/rev)

B14 = 44,0 B31 = 99,2
B17 = 55,0 B35 = 113,4
B20 = 66,0 B38 = 120,6
B22 = 70,3 B42 = 137,5
B24 = 81,1 045 = 145,7
B28 = 90,0 050 = 158,0

Displacement for "P3"

Volumetric displacement (ml/rev)

003 = 10,8 017 = 58,3
005 = 17,2 020 = 63,8
006 = 21,3 022 = 70,3
008 = 26,4 025 = 79,3
010 = 34,1 028 = 88,8
012 = 37,1 031 = 100,0
014 = 46,0

Type of shaft

1 = keyed (SAE C)
2 = keyed (SAE CC)
3 = splined 12/24 (SAE C) (14 teeth)
4 = splined 12/24 (SAE CC) (17 teeth)
5 = keyed (non SAE)

Modifications

Mounting w/connection variables

4 bolts SAE flange J518

P1 & P2 = 1.1/4" - S = 4"				
	Metric thread		UNC thread	
P3	1"	3/4"	1"	3/4"
Code	M0	M1	00	01

Seal class

1 = S1 BUNA N - 0,7 bar max. (for mineral oil)
4 = S4 EPDM - 7 bar max. (for fire resistant fluids)
5 = S5 VITON® - 7 bar max. (for mineral oil and fire resistant fluids)

Design letter

Porting combination (see pages 72 - 73)
00 = standard

Direction of rotation (shaft end view)

R = Clockwise
L = Counter-clockwise

OPERATING CHARACTERISTICS - TYPICAL [24 cSt]

Pressure port	Series	Vi Volumetric displacement	Flow q _v [l/min] & n = 1500 RPM			Input power P [kW] & n = 1500 RPM		
			p = 0 bar	p = 140 bar	p = 250 bar	p = 7 bar	p = 140 bar	p = 250 bar
P1 & P2	B14	44,0 ml/rev	66,0	59,4	54,2	1,5	16,6	29,0
	B17	55,0 ml/rev	82,5	75,9	70,7	1,7	20,4	35,8
	B20	66,0 ml/rev	99,0	92,4	87,2	1,9	24,3	42,7
	B22	70,3 ml/rev	105,5	98,8	93,7	2,0	25,8	45,4
	B24	81,1 ml/rev	121,7	115,0	109,9	2,2	29,5	52,1
	B28	90,0 ml/rev	135,0	128,4	123,2	2,3	32,7	57,7
	B31	99,2 ml/rev	148,8	142,2	137,0	2,5	35,9	63,5
	B35	113,4 ml/rev	170,1	163,5	158,3	2,7	40,8	72,3
	B38	120,6 ml/rev	180,9	174,3	169,1	2,9	43,4	76,8
	B42	137,5 ml/rev	206,3	199,6	194,5	3,2	49,3	87,4
	045	145,7 ml/rev	218,6	209,2	202,6 ¹⁾	4,1	52,8	89,5 ¹⁾
	050	158,0 ml/rev	237,0	227,7	223,0 ²⁾	4,4	57,1	85,0 ²⁾
			p = 0 bar	p = 140 bar	p = 275 bar	p = 7 bar	p = 140 bar	p = 275 bar
P3	003	10,8 ml/rev	16,2	11,2	*	1,3	5,3	*
	005	17,2 ml/rev	25,8	20,8	16,1	1,4	7,5	13,9
	006	21,3 ml/rev	31,9	26,9	22,2	1,5	8,9	16,8
	008	26,4 ml/rev	39,6	34,6	29,9	1,6	10,7	20,3
	010	34,1 ml/rev	51,1	46,1	41,4	1,7	13,4	25,6
	012	37,1 ml/rev	55,6	50,6	45,9	1,7	14,4	27,6
	014	46,0 ml/rev	69,0	64,0	59,3	1,9	17,6	33,7
	017	58,3 ml/rev	87,4	82,4	77,7	2,1	21,9	42,2
	020	63,8 ml/rev	95,7	90,7	86,0	2,2	23,8	46,0
	022	70,3 ml/rev	105,4	100,4	95,7	2,3	26,1	50,4
	025	79,3 ml/rev	118,9	113,9	109,2	2,5	29,2	56,6
	028	88,8 ml/rev	133,2	128,2	125,8 ²⁾	2,8	32,7	48,5 ²⁾
	031	100,0 ml/rev	150,0	145,0	142,6 ²⁾	2,8	36,5	54,4 ²⁾

* We do not recommend to use the size 003 in P3 at 275 bar & 1500 RPM as the internal leakage is over 50% of theoretical flow.

¹⁾ 045 = 240 bar max. int. ²⁾ 050 - 028 - 031 = 210 bar max. int.

INTERNAL LEAKAGE (TYPICAL)

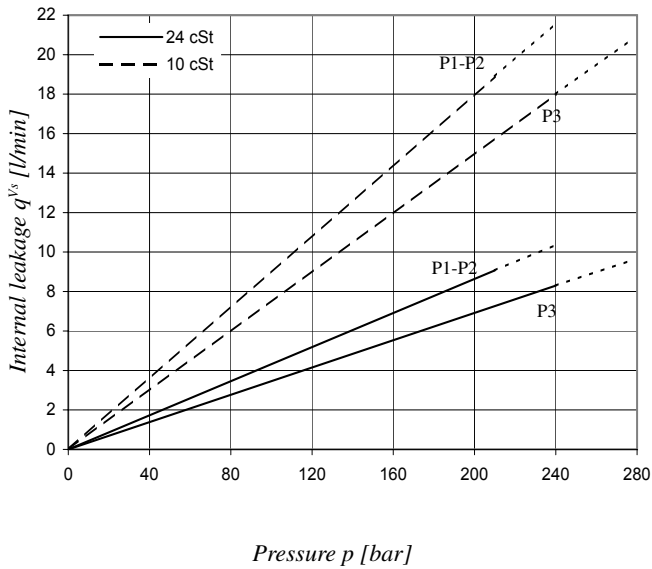

Do not operate pump more than 5 seconds at any speed or viscosity if internal leakage is higher than 50% of theoretical flow. Total leakage is the sum of each section loss under its respective operating conditions.

NOISE LEVEL (TYPICAL) - T67DDCS - B31 - B31 - 022

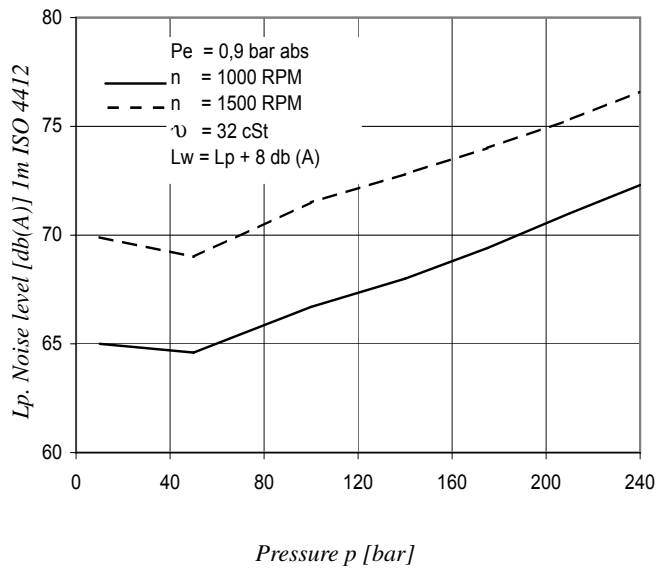

Triple pump noise level is given with all stages discharging at the pressure value indicated on the curve.

POWER LOSS HYDROMECHANICAL (TYPICAL)

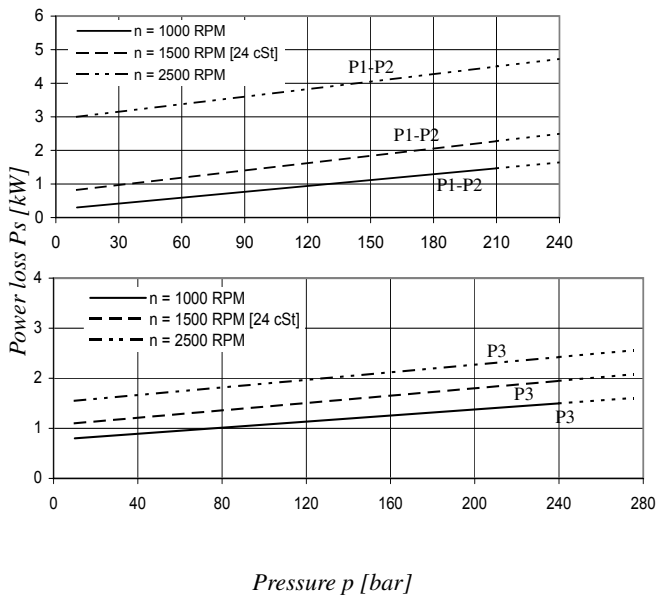

Total hydromechanical power loss is the sum of each section loss under its respective operating conditions.

PERMISSIBLE RADIAL LOAD

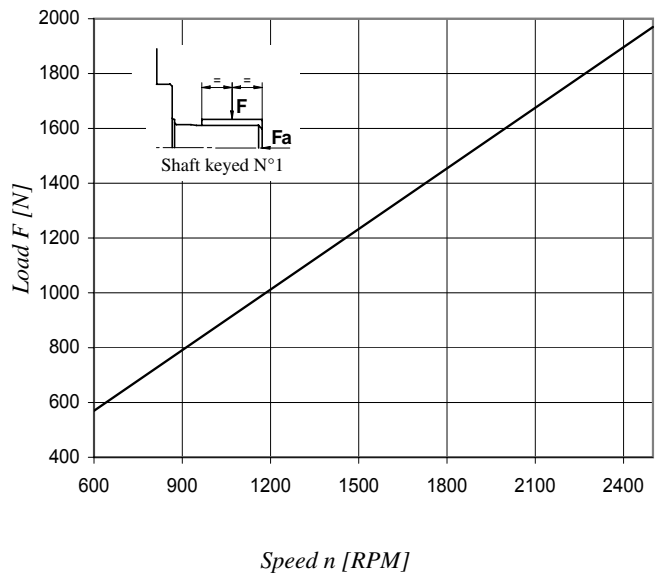

Maximum permissible axial load $F_a = 1200\text{ N}$

INTERNAL LEAKAGE (TYPICAL)

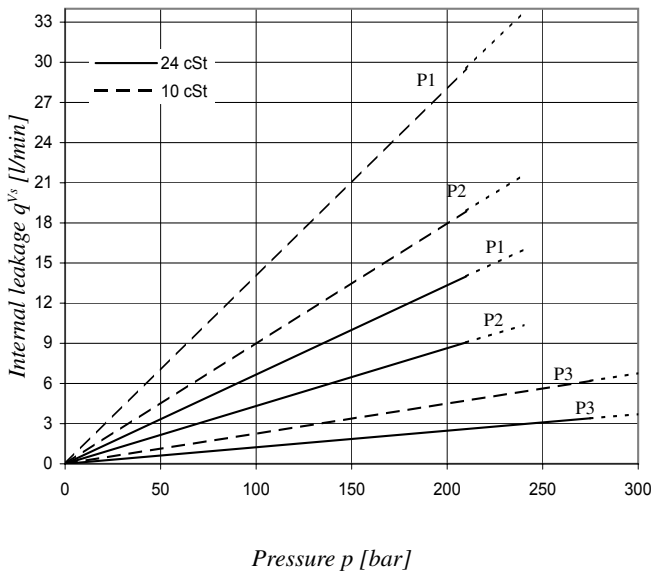

Do not operate pump more than 5 seconds at any speed or viscosity if internal leakage is higher than 50% of theoretical flow.
 Total leakage is the sum of each section loss under its respective operating conditions.

NOISE LEVEL (TYPICAL) - T7EDB - 062 - B35 - B04

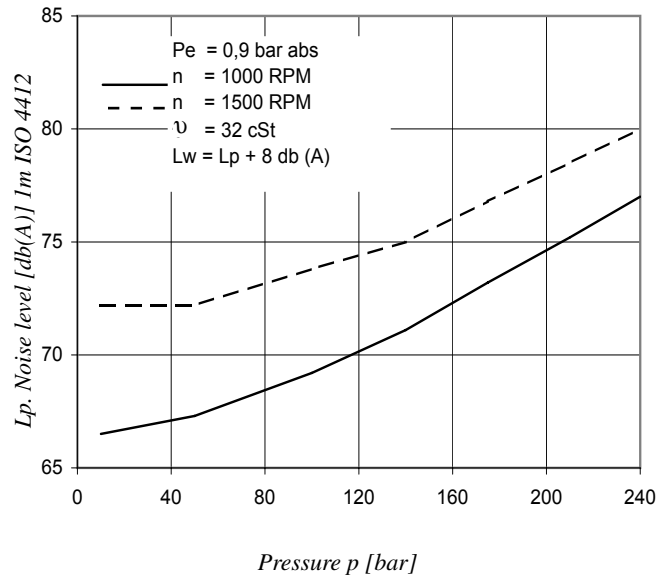

Triple pump noise level is given with all stages discharging at the pressure value indicated on the curve.

POWER LOSS HYDROMECHANICAL (TYPICAL)

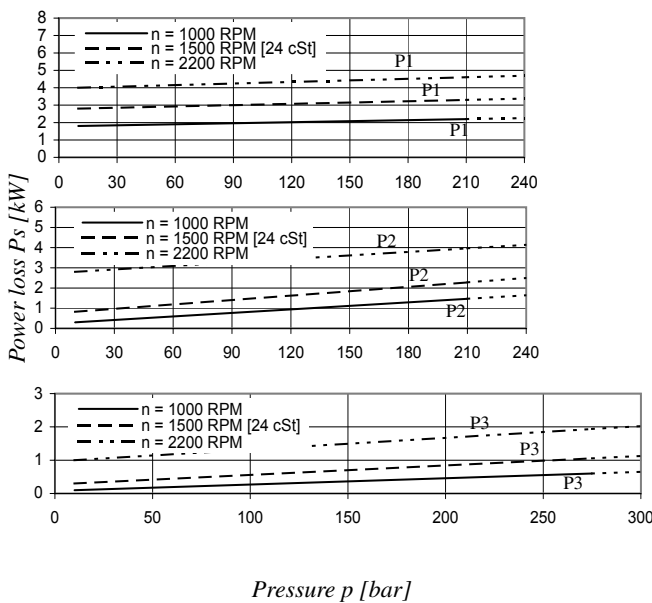

Total hydromechanical power loss is the sum of each section loss under its respective operating conditions.

PERMISSIBLE RADIAL LOAD

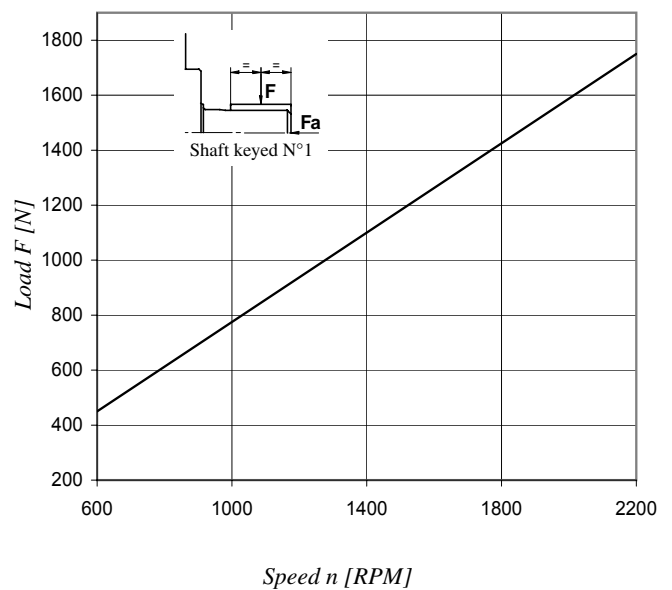

Maximum permissible axial load $F_a = 2000\text{ N}$

Model No. **T7EDB or T7EDBS - 062 - B35 - B10 - 1 R 00 - A 1 - 01 - ..**

T7EDB series - ISO 4 bolts 3019-2

Mounting flange 250-B4-HW

T7EDBS series - SAE E 4 bolts

J744 mounting flange

Displacement for "P1"

Volumetric displacement (ml/rev)

042 = 132,3 054 = 171,0 066 = 213,3

045 = 142,4 057 = 183,3 072 = 227,1

050 = 158,5 062 = 196,7 085 = 268,7

052 = 164,8

Displacement for "P2"

Volumetric displacement (ml/rev)

B14 = 44,0 B24 = 81,1 B38 = 120,6

B17 = 55,0 B28 = 90,0 B42 = 137,5

B20 = 66,0 B31 = 99,2 045 = 145,7

B22 = 70,3 B35 = 113,4 050 = 158,0

Displacement for "P3"

Volumetric displacement (ml/rev)

B02 = 5,8 B07 = 22,5 B11 = 35,0

B03 = 9,8 B08 = 24,9 B12 = 41,0

B04 = 12,8 B09 = 28,0 B14 = 45,0

B05 = 15,9 B10 = 31,8 B15 = 50,0

B06 = 19,8

Modifications

Mounting w/connection variables

4 bolts SAE flange J518

P1 = 1.1/2" - P2 = 1.1/4" - S = 4"		
	Metric thread	UNC thread
T7EDB-P3 = 1"	M0	
T7EDB-P3 = 3/4"	M1	
T7EDBS-P3 = 1"	M0	00
T7EDBS-P3 = 3/4"	M1	01

Seal class

1 = S1 BUNA N - 0,7 bar max. (for mineral oil)

4 = S4 EPDM - 7 bar max. (for fire resistant fluids)

5 = S5 VITON® - 7 bar max. (for mineral oil and fire resistant fluids)

Design letter

Porting combination (see pages 72 - 73)

00 = standard

Direction of rotation (shaft end view)

R = Clockwise L = Counter-clockwise

Type of shaft T7EDB

1 = keyed (ISO 3019/2 - G45N)

Type of shaft T7EDBS

2 = keyed (SAE D & E)

3 = splined 8/16 (SAE D & E) (13 teeth)

OPERATING CHARACTERISTICS - TYPICAL [24 cSt]

Pressure port	Series	Vi Volumetric displacement	Flow q _v [l/min] & n = 1500 RPM			Input power P [kW] & n = 1500 RPM		
			p = 0 bar	p = 140 bar	p = 240 bar	p = 7 bar	p = 140 bar	p = 240 bar
P1	042	132,3 ml/rev	198,5	188,5	181,3	5,2	49,4	82,6
	045	142,4 ml/rev	213,6	203,6	196,5	5,4	52,9	88,7
	050	158,5 ml/rev	237,7	227,7	220,6	5,7	58,5	98,3
	052	164,8 ml/rev	247,2	237,2	230,1	5,8	60,8	102,1
	054	171,0 ml/rev	256,5	246,5	239,4	5,9	63,0	105,8
	057	183,3 ml/rev	275,0	265,0	257,9	6,1	67,3	113,2
	062	196,7 ml/rev	295,0	285,0	277,9	6,4	71,9	121,3
	066	213,3 ml/rev	319,9	309,0	302,8	6,7	77,7	131,2
	072	227,1 ml/rev	340,6	330,6	323,5	6,9	82,6	139,5
	085	268,7 ml/rev	403,0	392,0 ¹⁾	-	9,1	65,8 ¹⁾	-
			p = 0 bar	p = 140 bar	p = 250 bar	p = 7 bar	p = 140 bar	p = 250 bar
P2	B14	44,0 ml/rev	66,0	59,4	54,2	1,5	16,6	29,0
	B17	55,0 ml/rev	82,5	75,9	70,7	1,7	20,4	35,8
	B20	66,0 ml/rev	99,0	92,4	87,2	1,9	24,3	42,7
	B22	70,3 ml/rev	105,5	98,8	93,7	2,0	25,8	45,4
	B24	81,1 ml/rev	121,7	115,0	109,9	2,2	29,5	52,1
	B28	90,0 ml/rev	135,0	128,4	123,2	2,3	32,7	57,7
	B31	99,2 ml/rev	148,8	142,2	137,0	2,5	35,9	63,5
	B35	113,4 ml/rev	170,1	163,5	158,3	2,7	40,8	72,3
	B38	120,6 ml/rev	180,9	174,3	169,1	2,9	43,4	76,8
	B42	137,5 ml/rev	206,3	199,6	194,5	3,2	49,3	87,4
	045	145,7 ml/rev	218,6	209,2	202,6 ³⁾	4,1	52,8	89,5 ³⁾
	050	158,0 ml/rev	237,0	227,7	223,0 ²⁾	4,4	57,1	85,0 ²⁾
			p = 0 bar	p = 140 bar	p = 300 bar	p = 7 bar	p = 140 bar	p = 300 bar
P3	B02	5,8 ml/rev	8,7	7,0	5,1	0,5	2,6	5,1
	B03	9,8 ml/rev	14,7	13,0	11,1	0,6	4,0	8,1
	B04	12,8 ml/rev	19,2	17,5	15,6	0,6	5,0	10,4
	B05	15,9 ml/rev	23,9	22,2	20,2	0,7	6,1	12,7
	B06	19,8 ml/rev	29,7	28,0	26,1	0,7	7,5	15,6
	B07	22,5 ml/rev	33,7	32,0	30,2	0,8	8,5	17,6
	B08	24,9 ml/rev	37,4	35,7	33,7	0,8	9,3	19,5
	B09	28,0 ml/rev	42,0	40,3	38,4	0,9	10,4	21,8
	B10	31,8 ml/rev	47,7	46,0	44,1	0,9	11,7	26,2
	B11	35,0 ml/rev	52,5	50,8	48,9	1,0	12,8	27,0
	B12	41,0 ml/rev	61,5	59,8	57,9	1,1	14,9	31,5
	B14	45,0 ml/rev	67,5	65,8	63,9	1,2	16,3	34,5
B15	50,0 ml/rev	75,0	73,3	71,6 ⁴⁾	1,3	18,1	35,7 ⁴⁾	

¹⁾ 085 = 90 bar max. int.

²⁾ 050 = 210 bar max. int.

³⁾ 045 = 240 bar max. int.

⁴⁾ B15 = 280 bar max. int.

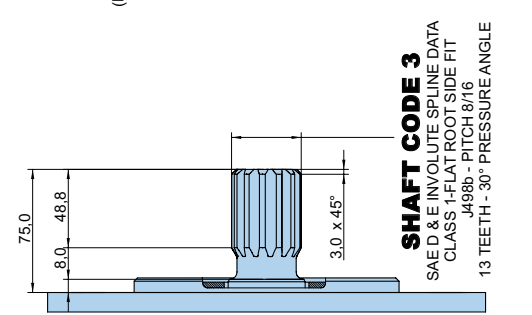
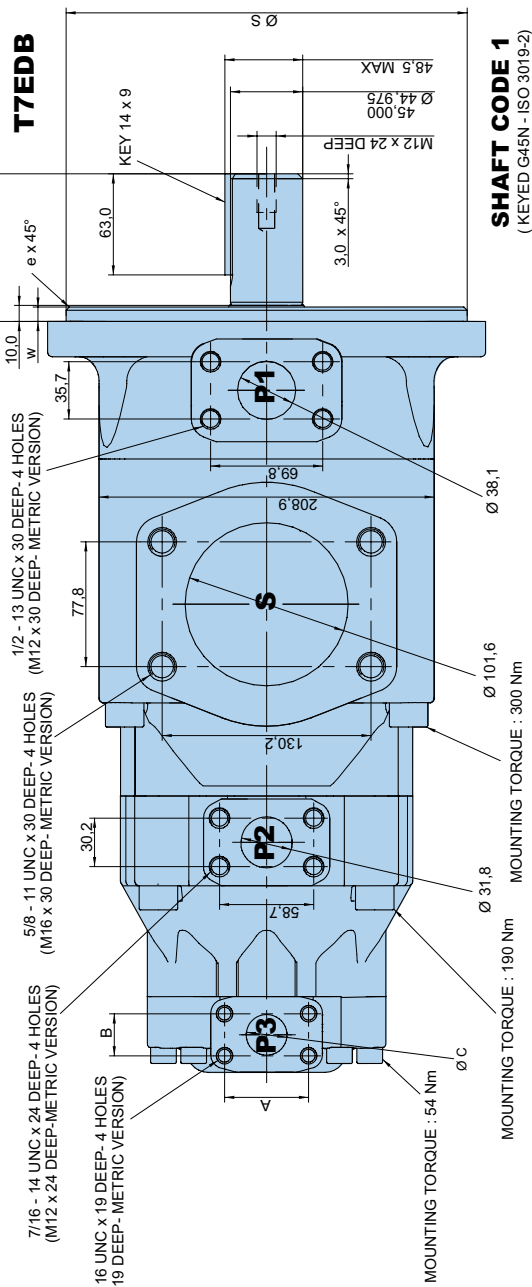
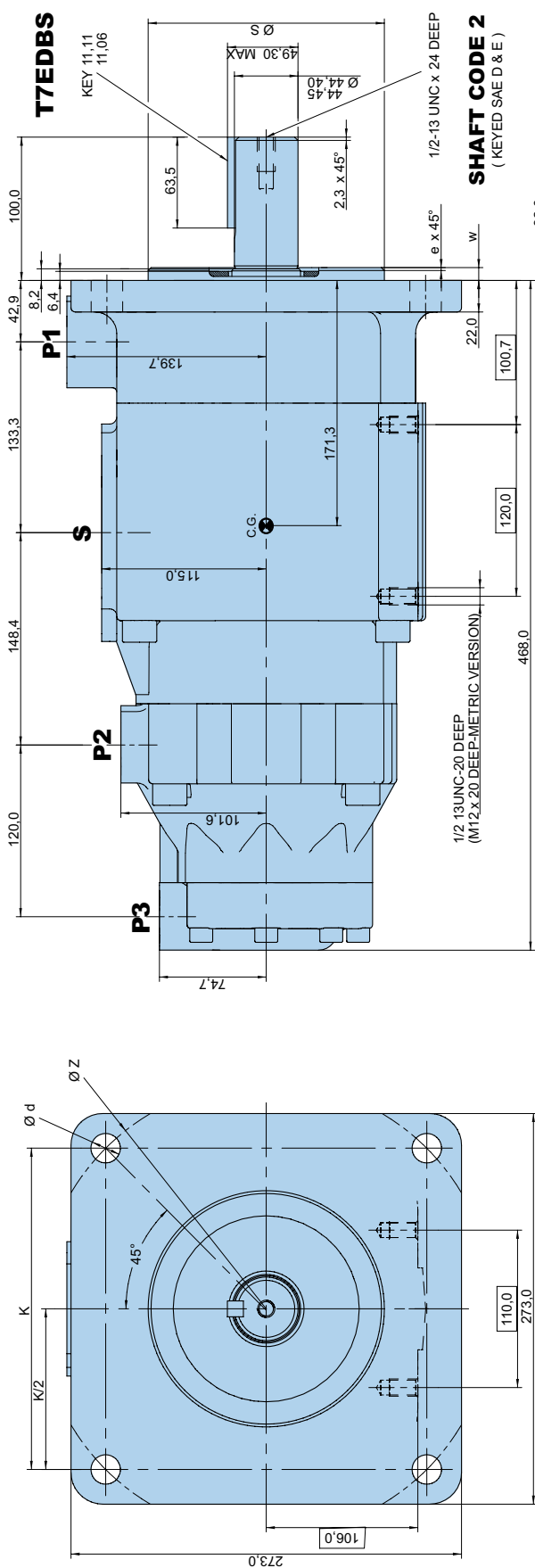

SHAFT CODE 3

SAE D & E INVOLUTE SPLINE DATA
CLASS 1-FLAT ROOT SIDE FIT
J4988 - PITCH 8/16
13 TEETH - 30° PRESSURE ANGLE

Alternate connect. variables	
	00 & M0 01 & M1
A	52,4 47,6
B	26,2 22,2
C	25,4 19,0

Series	Alternate mounting flange					
	Dia S	e x 45°	W	K	Dia Z	Dia d
T7EDB	Max. 250,000	2,0	9,0	-	315	22,0
T7EDBS	165,100	165,050	2,0	9,0	224,5	20,6

Shaft torque limits [ml/rev. x bar]	
Shaft	Vi x p max. P1 + P2 + P3
1	114600
2	118340
3	126800



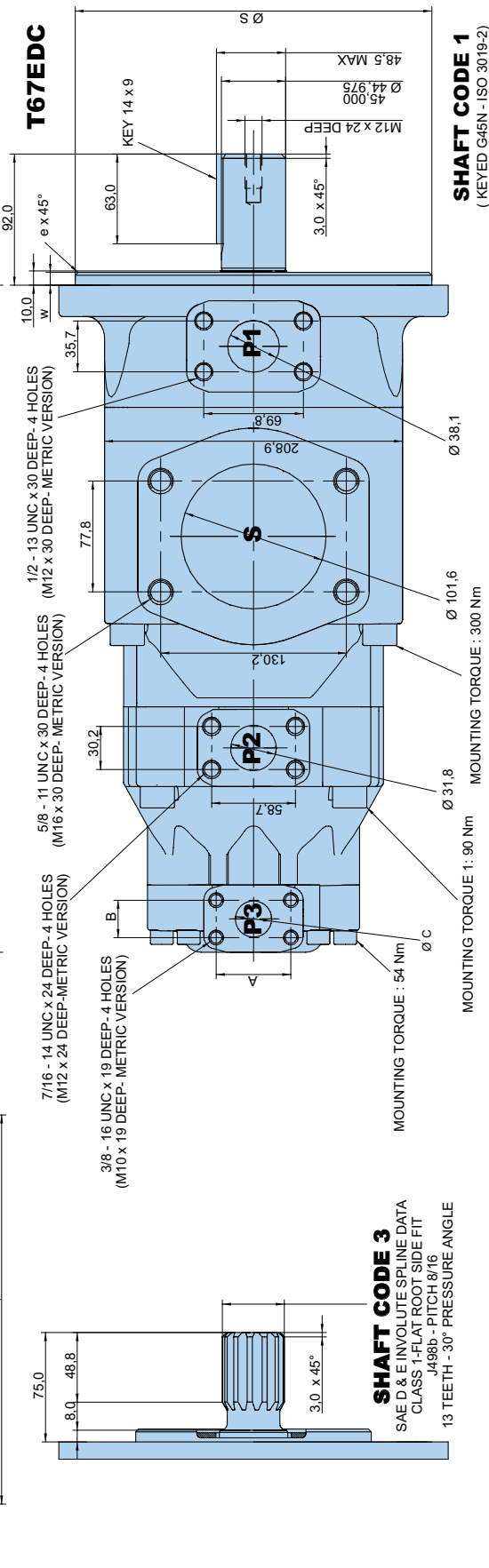
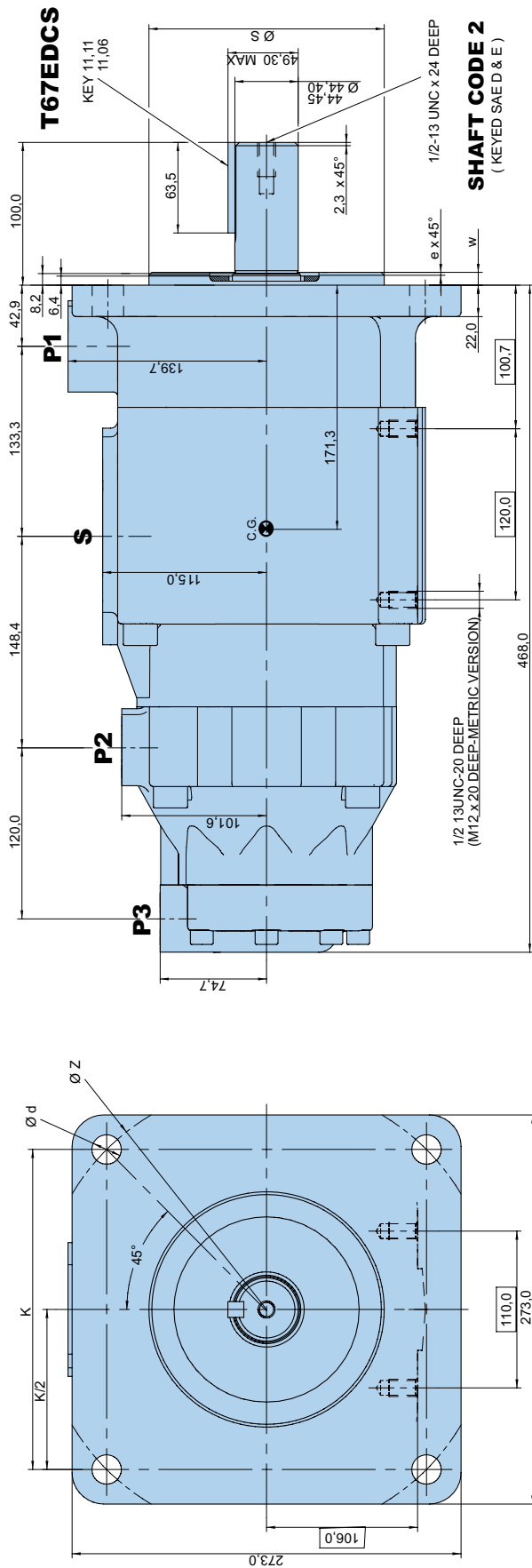

Alternate connect. variables	
	00
A	52,4
B	26,2
C	25,4
	01
	47,6
	22,2
	19,0

Series	Dia S		W	K	Dia Z	Dia d
	Max.	Min.				
T67EDC	250,000	249,928	2,0	9,0	-	22,0
T67EDCS	165,100	165,050	2,0	9,0	224,5	20,6

Shaft torque limits [ml/rev. x bar]	
Shaft	V1 x p max. P1 + P2 + P3
1	114600
2	118340
3	126800

Model No. T67EDC or T67EDCS - 062 - B35 - 010 - 1 R 00 - A 1 - M1 - ..

T67EDC series - ISO 4 bolts 3019-2

Mounting flange 250-B4-HW

T67EDCS series - SAE E 4 bolts

J744 mounting flange

P1 P2 P3

Modifications

Mounting w/connection variables

4 bolts SAE flange J518

P1 = 1.1/2" - P2 = 1.1/4" - S = 4"		
	Metric thread	UNC thread
T67EDC-P3 = 1"	M0	
T67EDC-P3 = 3/4"	M1	
T67EDCS-P3 = 1"	M0	00
T67EDCS-P3 = 3/4"	M1	01

Displacement for "P1"

Volumetric displacement (ml/rev)

042 = 132,3 054 = 171,0 066 = 213,3

045 = 142,4 057 = 183,3 072 = 227,1

050 = 158,5 062 = 196,7 085 = 268,7

052 = 164,8

Displacement for "P2"

Volumetric displacement (ml/rev)

B14 = 44,0 B24 = 81,1 B38 = 120,6

B17 = 55,0 B28 = 90,0 B42 = 137,5

B20 = 66,0 B31 = 99,2 045 = 145,7

B22 = 70,3 B35 = 113,4 050 = 158,0

Displacement for "P3"

Volumetric displacement (ml/rev)

003 = 10,8 012 = 37,1 022 = 70,3

005 = 17,2 014 = 46,0 025 = 79,3

006 = 21,3 017 = 58,3 028 = 88,8

008 = 26,4 020 = 63,8 031 = 100,0

010 = 34,1

Seal class

1 = S1 BUNA N - 0,7 bar max. (for mineral oil)

4 = S4 EPDM - 7 bar max. (for fire resistant fluids)

5 = S5 VITON® - 7 bar max. (for mineral oil and fire resistant fluids)

Design letter

Porting combination (see pages 72 - 73)

00 = standard

Direction of rotation (shaft end view)

R = Clockwise L = Counter-clockwise

Type of shaft T67EDC

1 = keyed (ISO 3019/2 - G45N)

Type of shaft T67EDCS

2 = keyed (SAE D & E)

3 = splined 8/16 (SAE D & E) (13 teeth)

OPERATING CHARACTERISTICS - TYPICAL [24 cSt]

Pressure port	Series	Vi Volumetric displacement	Flow q _v [l/min] & n = 1500 RPM			Input power P [kW] & n = 1500 RPM		
			p = 0 bar	p = 140 bar	p = 240 bar	p = 7 bar	p = 140 bar	p = 240 bar
P1	042	132,3 ml/rev	198,5	188,5	181,3	5,2	49,4	82,6
	045	142,4 ml/rev	213,6	203,6	196,5	5,4	52,9	88,7
	050	158,5 ml/rev	237,7	227,7	220,6	5,7	58,5	98,3
	052	164,8 ml/rev	247,2	237,2	230,1	5,8	60,8	102,1
	054	171,0 ml/rev	256,5	246,5	239,4	5,9	63,0	105,8
	057	183,3 ml/rev	275,0	265,0	257,9	6,1	67,3	113,2
	062	196,7 ml/rev	295,0	285,0	277,9	6,4	71,9	121,3
	066	213,3 ml/rev	319,9	309,0	302,8	6,7	77,7	131,2
	072	227,1 ml/rev	340,6	330,6	323,5	6,9	82,6	139,5
	085	268,7 ml/rev	403,0	392,0 ²⁾	-	9,1	65,8 ²⁾	-
P2			p = 0 bar	p = 140 bar	p = 250 bar	p = 7 bar	p = 140 bar	p = 250 bar
	B14	44,0 ml/rev	66,0	59,4	54,2	1,5	16,6	29,0
	B17	55,0 ml/rev	82,5	75,9	70,7	1,7	20,4	35,8
	B20	66,0 ml/rev	99,0	92,4	87,2	1,9	24,3	42,7
	B22	70,3 ml/rev	105,5	98,8	93,7	2,0	25,8	45,4
	B24	81,1 ml/rev	121,7	115,0	109,9	2,2	29,5	52,1
	B28	90,0 ml/rev	135,0	128,4	123,2	2,3	32,7	57,7
	B31	99,2 ml/rev	148,8	142,2	137,0	2,5	35,9	63,5
	B35	113,4 ml/rev	170,1	163,5	158,3	2,7	40,8	72,3
	B38	120,6 ml/rev	180,9	174,3	169,1	2,9	43,4	76,8
	B42	137,5 ml/rev	206,3	199,6	194,5	3,2	49,3	87,4
	045	145,7 ml/rev	218,6	209,2	202,6 ³⁾	4,1	52,8	89,5 ³⁾
	050	158,0 ml/rev	237,0	227,7	223,0 ¹⁾	4,4	57,1	85,0 ¹⁾
P3			p = 0 bar	p = 140 bar	p = 275 bar	p = 7 bar	p = 140 bar	p = 275 bar
	003	10,8 ml/rev	16,2	11,2	*	1,3	5,3	*
	005	17,2 ml/rev	25,8	20,8	16,1	1,4	7,5	13,9
	006	21,3 ml/rev	31,9	26,9	22,2	1,5	8,9	16,8
	008	26,4 ml/rev	39,6	34,6	29,9	1,6	10,7	20,3
	010	34,1 ml/rev	51,1	46,1	41,4	1,7	13,4	25,6
	012	37,1 ml/rev	55,6	50,6	45,9	1,7	14,4	27,6
	014	46,0 ml/rev	69,0	64,0	59,3	1,9	17,6	33,7
	017	58,3 ml/rev	87,4	82,4	77,7	2,1	21,9	42,2
	020	63,8 ml/rev	95,7	90,7	86,0	2,2	23,8	46,0
	022	70,3 ml/rev	105,4	100,4	95,7	2,3	26,1	50,4
	025	79,3 ml/rev	118,9	113,9	109,2	2,5	29,2	56,6
	028	88,8 ml/rev	133,2	128,2	125,8 ¹⁾	2,8	32,7	48,5 ¹⁾
	031	100,0 ml/rev	150,0	145,0	142,6 ¹⁾	2,8	36,5	54,4 ¹⁾

* We do not recommend to use the size 003 in P3 at 275 bar & 1500 RPM as the internal leakage is over 50% of theoretical flow.

¹⁾ 050 - 028 - 031 = 210 bar max. int.

²⁾ 085 = 90 bar max. int.

³⁾ 045 = 240 bar max. int.

INTERNAL LEAKAGE (TYPICAL)

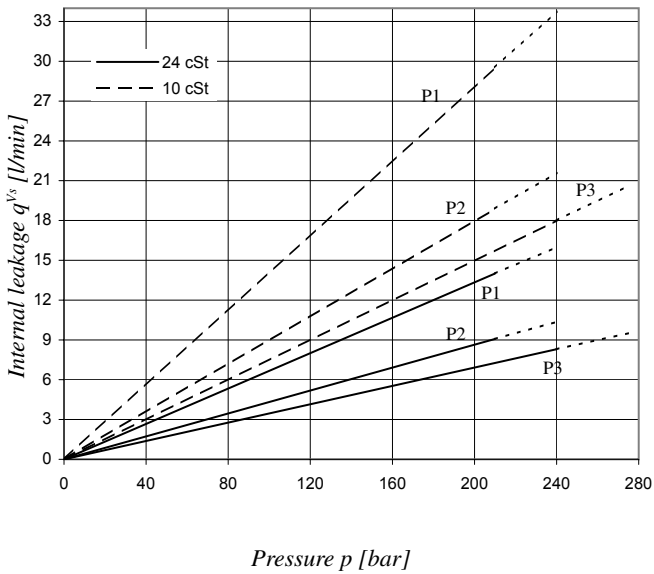

Do not operate pump more than 5 seconds at any speed or viscosity if internal leakage is higher than 50% of theoretical flow.
 Total leakage is the sum of each section loss under its respective operating conditions.

NOISE LEVEL (TYPICAL) - T67EDCS - 062 - B35 - 022

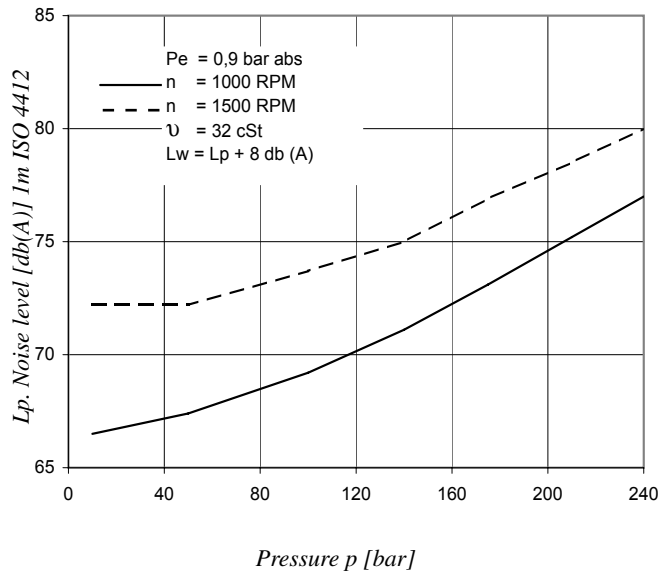

Triple pump noise level is given with all stages discharging at the pressure value indicated on the curve.

POWER LOSS HYDROMECHANICAL (TYPICAL)

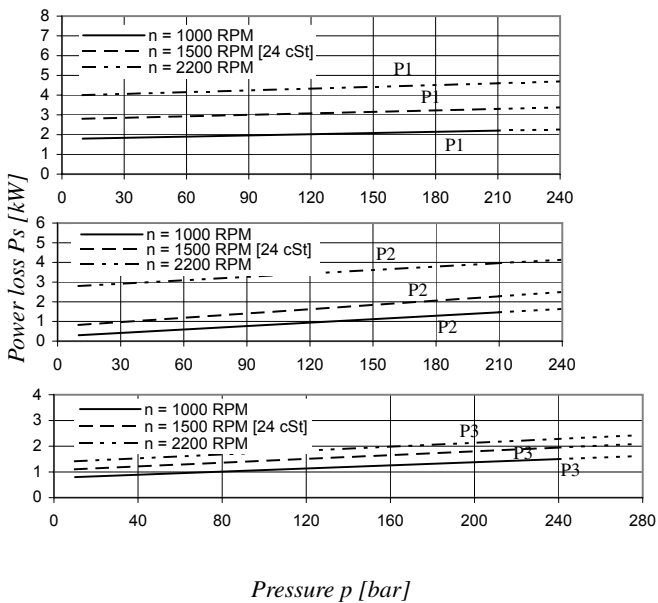

Total hydromechanical power loss is the sum of each section loss under its respective operating conditions.

PERMISSIBLE RADIAL LOAD

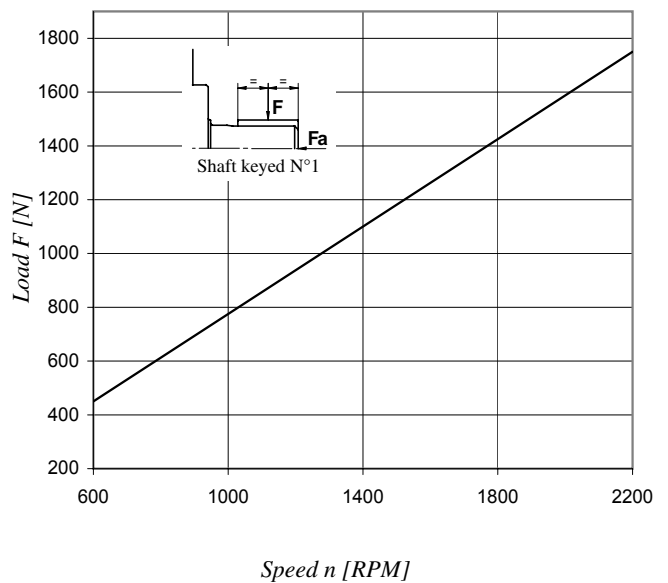

Maximum permissible axial load $F_a = 2000\text{ N}$

INTERNAL LEAKAGE (TYPICAL)

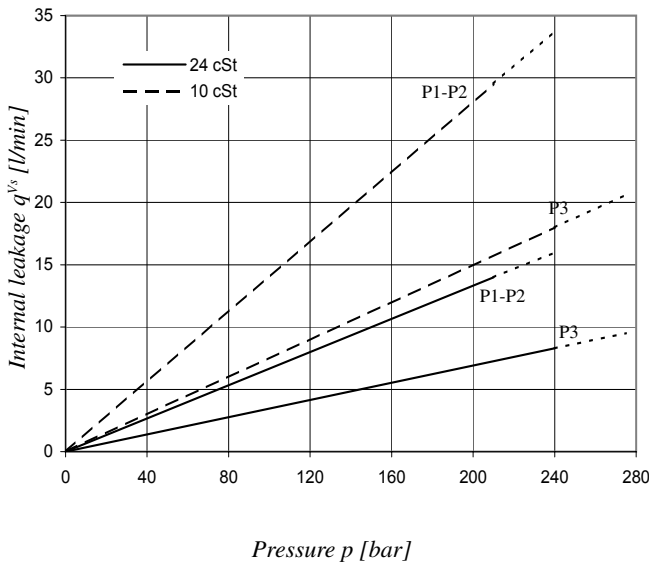

Do not operate pump more than 5 seconds at any speed or viscosity if internal leakage is higher than 50% of theoretical flow.
 Total leakage is the sum of each section loss under its respective operating conditions.

NOISE LEVEL (TYPICAL) - T7EECS - 052 - 052 - 025

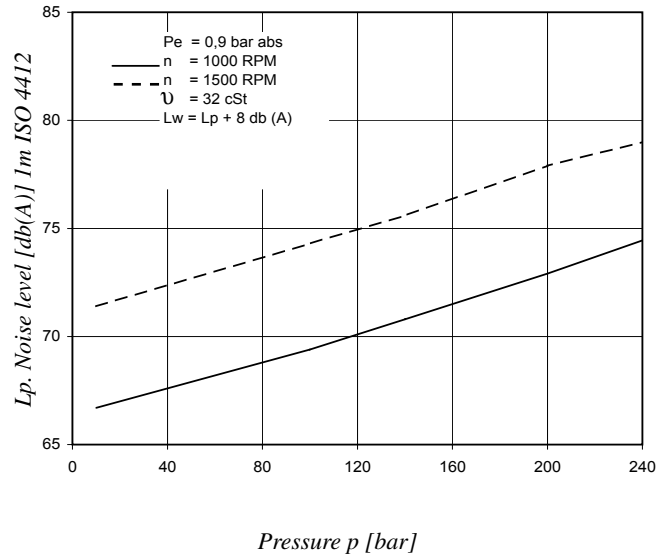

Triple pump noise level is given with all stages discharging at the pressure value indicated on the curve.

POWER LOSS HYDROMECHANICAL (TYPICAL)

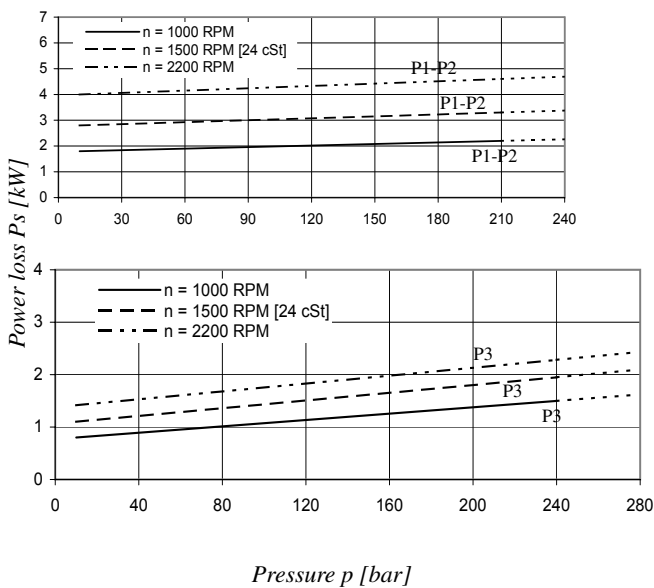

Total hydromechanical power loss is the sum of each section loss under its respective operating conditions.

PERMISSIBLE RADIAL LOAD

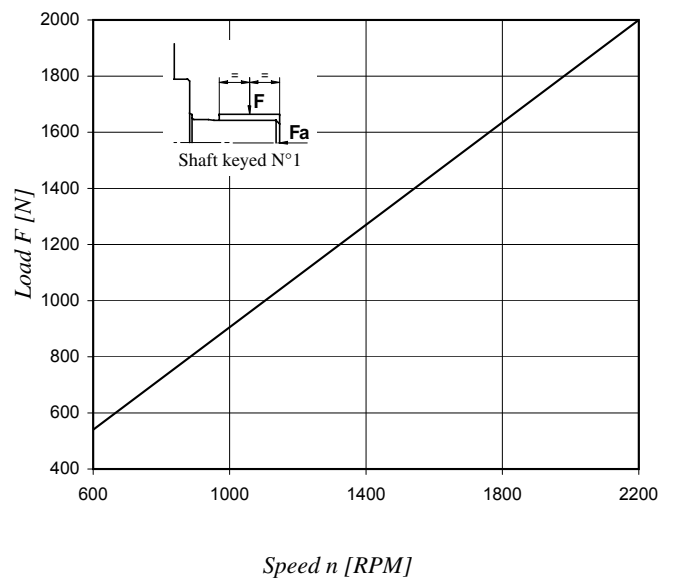

Maximum permissible axial load $F_a = 2000\text{ N}$

Model No. **T7EEC or T7EECS - 062 - 062 - 017 - 2 R 00 - A 1 - M0 - ..**

T7EEC series - 250-B4-HW
ISO 4 bolts 3019-2 mounting flange

T7EECS series - SAE E 4 bolts
J744 mounting flange

Displacement for "P1" & "P2"

Volumetric displacement (ml/rev)

042 = 132,3 057 = 183,3
045 = 142,4 062 = 196,7
050 = 158,5 066 = 213,3
052 = 164,8 072 = 227,1
054 = 171,0 085 = 268,7

Displacement for "P3"

Volumetric displacement (ml/rev.)

003 = 10,8 017 = 58,3
005 = 17,2 020 = 63,8
006 = 21,3 022 = 70,3
008 = 26,4 025 = 79,3
010 = 34,1 028 = 88,8
012 = 37,1 031 = 100,0
014 = 46,0

Modifications

Mounting w/connection variables

4 bolts SAE flange J518

P1 = 1.1/2" - P2 = 1.1/2" - P3 = 3/4" & 1" - S = 4"

	Metric	UNC
T7EEC - 3/4"	M1	
T7EECS - 3/4"	M1	01
T7EEC - 1"	M0	
T7EECS - 1"	M0	00

Seal class

1 = S1 BUNA N - 0,7 bar max. (for mineral oil)

Design letter

Porting combination (see pages 72 - 73)

00 = standard

Direction of rotation (shaft end view)

R = Clockwise

L = Counter-clockwise

Type of shaft T7EEC - T7EECS

2 = keyed (ISO 3019/2 - G45N))

Type of shaft T7EECS

4 = splined 8/16 (SAE D & E) (13 teeth)

OPERATING CHARACTERISTICS - TYPICAL [24 cSt]

Pressure port	Series	Vi Volumetric displacement	Flow q _v [l/min] & n = 1500 RPM			Input power P [kW] & n = 1500 RPM		
			p = 0 bar	p = 140 bar	p = 240 bar	p = 7 bar	p = 140 bar	p = 240 bar
P1 & P2	042	132,3 ml/rev	198,5	188,5	181,3	5,2	49,4	82,6
	045	142,4 ml/rev	213,6	203,6	196,5	5,4	52,9	88,7
	050	158,5 ml/rev	237,7	227,7	220,6	5,7	58,5	98,3
	052	164,8 ml/rev	247,2	237,2	230,1	5,8	60,8	102,1
	054	171,0 ml/rev	256,5	246,5	239,4	5,9	63,0	105,8
	057	183,3 ml/rev	275,0	265,0	257,9	6,1	67,3	113,2
	062	196,7 ml/rev	295,0	285,0	277,9	6,4	71,9	121,3
	066	213,3 ml/rev	319,9	309,0	302,8	6,7	77,7	131,2
	072	227,1 ml/rev	340,6	330,6	323,5	6,9	82,6	139,5
	085	268,7 ml/rev	403,0	392,0 ²⁾	-	9,1	65,8 ²⁾	-
			p = 0 bar	p = 140 bar	p = 275 bar	p = 7 bar	p = 140 bar	p = 275 bar
P3	003	10,8 ml/rev	16,2	11,2	*	1,3	5,3	*
	005	17,2 ml/rev	25,8	20,8	16,1	1,4	7,5	13,9
	006	21,3 ml/rev	31,9	26,9	22,2	1,5	8,9	16,8
	008	26,4 ml/rev	39,6	34,6	29,9	1,6	10,7	20,3
	010	34,1 ml/rev	51,1	46,1	41,4	1,7	13,4	25,6
	012	37,1 ml/rev	55,6	50,6	45,9	1,7	14,4	27,6
	014	46,0 ml/rev	69,0	64,0	59,3	1,9	17,6	33,7
	017	58,3 ml/rev	87,4	82,4	77,7	2,1	21,9	42,2
	020	63,8 ml/rev	95,7	90,7	86,0	2,2	23,8	46,0
	022	70,3 ml/rev	105,4	100,4	95,7	2,3	26,1	50,4
	025	79,3 ml/rev	118,9	113,9	109,2	2,5	29,2	56,6
	028	88,8 ml/rev	133,2	128,2	125,8 ¹⁾	2,8	32,7	48,5 ¹⁾
	031	100,0 ml/rev	150,0	145,0	142,6 ¹⁾	2,8	36,5	54,4 ¹⁾

* We do not recommend to use the size 003 in P3 at 275 bar & 1500 RPM as the internal leakage is over 50% of theoretical flow.

¹⁾ 028 - 031 = 210 bar max.int. ²⁾ 085 = 90 bar max.int.

Porting Diagrams

Hydraulic Pumps

T7/T67/T6C Industrial, Denison Vane Pumps

T7BB/T7BBS

T6CC

T67CB

T7DB/T7DBS

T67DC

T7EB/T7EBS

T67EC

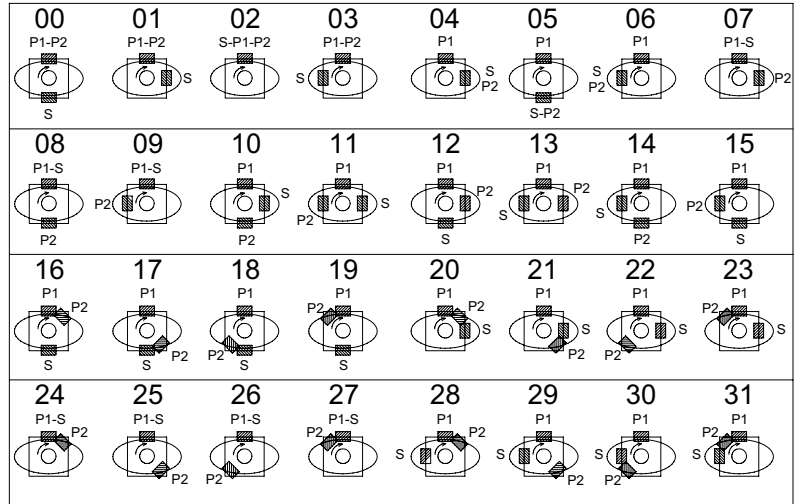

T7DD/T7DDS

T7ED/T7EDS

T7EE/T7EES

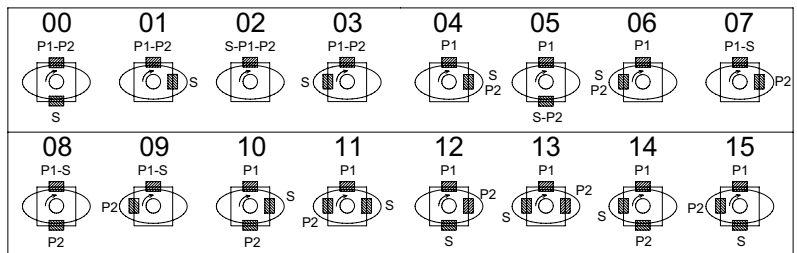

T7DBB/T7DBBS

T7DCB/T7DCBS

T7DCC/T7DCCS

T7DBB/T7DBBS

T67DDCS

T7EDB/T7EDBS

T67EDC/T67EDCS

T7EEC/T7EECS

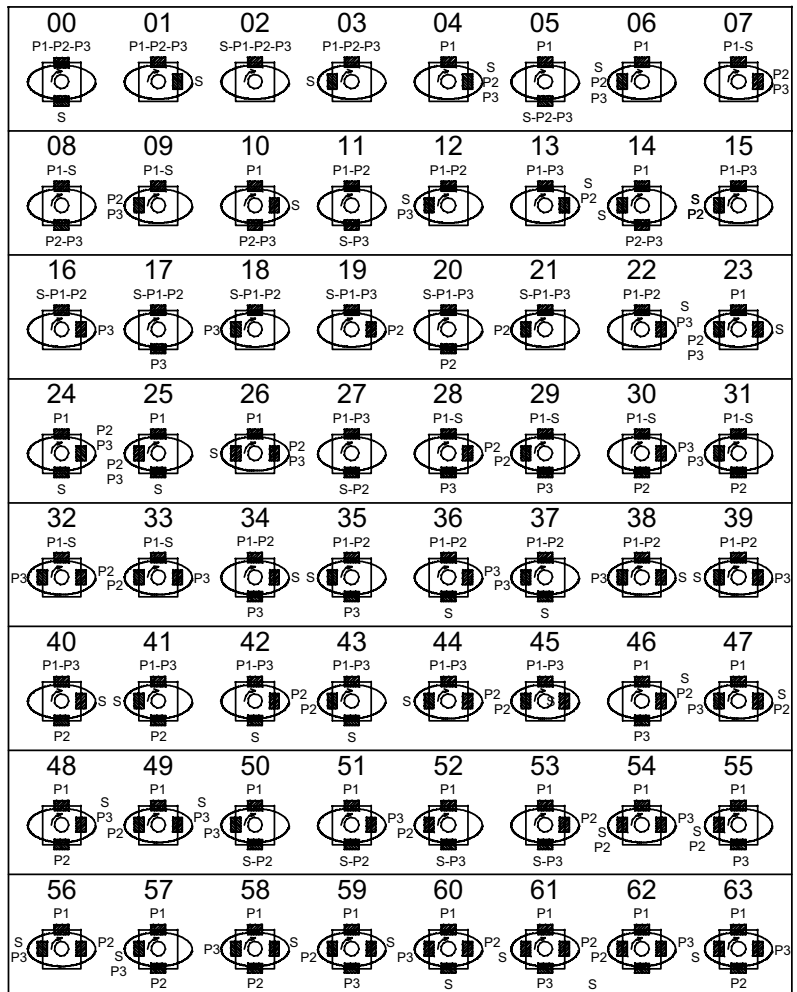

Porting Diagrams

Hydraulic Pumps

T7/T67/T6C Industrial, Denison Vane Pumps

- T7DBB/T7DBBS
- T7DCB/T7DCBS
- T7DCC/T7DCCS
- T7DBB/T7DBBS
- T67DDCS
- T7EDB/T7EDBS
- T67EDC/T67EDCS
- T7EEC/T7EECS

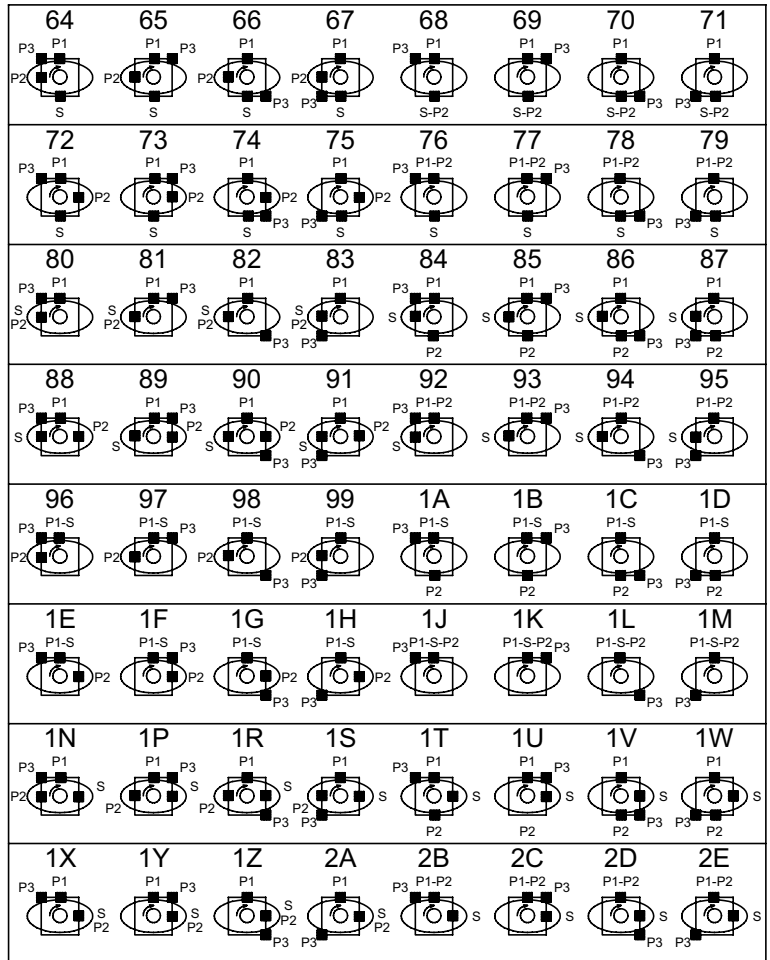

	S	P2	P3				P2	P3			
			02	16	17	18		20	30	08	31
			19	07	28	32		21	33	29	09
			01	22	34	38		40	48	10	58
			13	04	46	47		45	49	59	23
			00	36	11	37		27	51	05	50
			42	24	53	60		43	62	52	25
			03	39	35	12		41	63	14	57
			44	26	61	56		15	54	55	06



WARNING — USER RESPONSIBILITY

FAILURE OR IMPROPER SELECTION OR IMPROPER USE OF THE PRODUCTS DESCRIBED HEREIN OR RELATED ITEMS CAN CAUSE DEATH, PERSONAL INJURY AND PROPERTY DAMAGE.

- This document and other information from Parker-Hannifin Corporation, its subsidiaries and authorized distributors provide product or system options for further investigation by users having technical expertise.

- The user, through its own analysis and testing, is solely responsible for making the final selection of the system and components and assuring that all performance, endurance, maintenance, safety and warning requirements of the application are met. The user must analyze all aspects of the application, follow applicable industry standards, and follow the information concerning the product in the current product catalog and in any other materials provided from Parker or its subsidiaries or authorized distributors.

- To the extent that Parker or its subsidiaries or authorized distributors provide component or system options based upon data or specifications provided by the user, the user is responsible for determining that such data and specifications are suitable and sufficient for all applications and reasonably foreseeable uses of the components or systems.

Offer of Sale

Please contact your Parker representation for a detailed "Offer of Sale".

Parker Worldwide

AE – UAE, Dubai
Tel: +971 4 8127100
parker.me@parker.com

AR – Argentina, Buenos Aires
Tel: +54 3327 44 4129

AT – Austria, Wiener Neustadt
Tel: +43 (0)2622 23501-0
parker.austria@parker.com

AT – Eastern Europe, Wiener Neustadt
Tel: +43 (0)2622 23501 900
parker.easteurope@parker.com

AU – Australia, Castle Hill
Tel: +61 (0)2-9634 7777

AZ – Azerbaijan, Baku
Tel: +994 50 2233 458
parker.azerbaijan@parker.com

BE/LU – Belgium, Nivelles
Tel: +32 (0)67 280 900
parker.belgium@parker.com

BR – Brazil, Cachoeirinha RS
Tel: +55 51 3470 9144

BY – Belarus, Minsk
Tel: +375 17 209 9399
parker.belarus@parker.com

CA – Canada, Milton, Ontario
Tel: +1 905 693 3000

CH – Switzerland, Etoy
Tel: +41 (0) 21 821 02 30
parker.switzerland@parker.com

CL – Chile, Santiago
Tel: +56 2 623 1216

CN – China, Shanghai
Tel: +86 21 2899 5000

CZ – Czech Republic, Klecany
Tel: +420 284 083 111
parker.czechrepublic@parker.com

DE – Germany, Kaarst
Tel: +49 (0)2131 4016 0
parker.germany@parker.com

DK – Denmark, Ballerup
Tel: +45 43 56 04 00
parker.denmark@parker.com

ES – Spain, Madrid
Tel: +34 902 330 001
parker.spain@parker.com

FI – Finland, Vantaa
Tel: +358 (0)20 753 2500
parker.finland@parker.com

FR – France, Contamine s/Arve
Tel: +33 (0)4 50 25 80 25
parker.france@parker.com

GR – Greece, Athens
Tel: +30 210 933 6450
parker.greece@parker.com

HK – Hong Kong
Tel: +852 2428 8008

HU – Hungary, Budapest
Tel: +36 1 220 4155
parker.hungary@parker.com

IE – Ireland, Dublin
Tel: +353 (0)1 466 6370
parker.ireland@parker.com

IN – India, Mumbai
Tel: +91 22 6513 7081-85

IT – Italy, Corsico (MI)
Tel: +39 02 45 19 21
parker.italy@parker.com

JP – Japan, Fujisawa
Tel: +(81) 4 6635 3050

KR – South Korea, Seoul
Tel: +82 2 559 0400

KZ – Kazakhstan, Almaty
Tel: +7 7272 505 800
parker.easteurope@parker.com

LV – Latvia, Riga
Tel: +371 6 745 2601
parker.latvia@parker.com

MX – Mexico, Apodaca
Tel: +52 81 8156 6000

MY – Malaysia, Shah Alam
Tel: +60 3 7849 0800

NL – The Netherlands, Oldenzaal
Tel: +31 (0)541 585 000
parker.nl@parker.com

NO – Norway, Ski
Tel: +47 64 91 10 00
parker.norway@parker.com

NZ – New Zealand, Mt Wellington
Tel: +64 9 574 1744

PL – Poland, Warsaw
Tel: +48 (0)22 573 24 00
parker.poland@parker.com

PT – Portugal, Leca da Palmeira
Tel: +351 22 999 7360
parker.portugal@parker.com

RO – Romania, Bucharest
Tel: +40 21 252 1382
parker.romania@parker.com

RU – Russia, Moscow
Tel: +7 495 645-2156
parker.russia@parker.com

SE – Sweden, Spånga
Tel: +46 (0)8 59 79 50 00
parker.sweden@parker.com

SG – Singapore
Tel: +65 6887 6300

SK – Slovakia, Banská Bystrica
Tel: +421 484 162 252
parker.slovakia@parker.com

SL – Slovenia, Novo Mesto
Tel: +386 7 337 6650
parker.slovenia@parker.com

TH – Thailand, Bangkok
Tel: +662 717 8140

TR – Turkey, Istanbul
Tel: +90 216 4997081
parker.turkey@parker.com

TW – Taiwan, Taipei
Tel: +886 2 2298 8987

UA – Ukraine, Kiev
Tel: +380 44 494 2731
parker.ukraine@parker.com

UK – United Kingdom, Warwick
Tel: +44 (0)1926 317 878
parker.uk@parker.com

US – USA, Cleveland (industrial)
Tel: +1 216 896 3000

US – USA, Lincolnshire (mobile)
Tel: +1 847 821 1500

VE – Venezuela, Caracas
Tel: +58 212 238 5422

ZA – South Africa, Kempton Park
Tel: +27 (0)11 961 0700
parker.southafrica@parker.com

European Product Information Centre
Free phone: 00 800 27 27 5374
(from AT, BE, CH, CZ, DE, DK, EE, ES, FI, FR, IE, IL, IS, IT, LU, MT, NL, NO, PL, PT, RU, SE, UK, ZA)



Parker Hannifin Ltd.
Tachbrook Park Drive
Tachbrook Park, Warwick CV34 6TU
United Kingdom
Tel.: +44 (0) 1926 317 878
Fax: +44 (0) 1926 317 855
www.parker.com