

Electronic lubrication control unit

Model 85307; progressive-line system



Date of issue	August 2020
Form number	404771
Version	2

Contents

Description	3
Features	3
Specifications	3
Safety	4
Operational precautions	4
Explanation of signal words for safety	4
Keypad layout	5
LED code descriptions	6
Setup mode	
Progressive-line system with no monitoring	10
Running system (pump run)	14
Running system (pump pause)	14
Wiring diagram of progressive-line system without sensors	15
Wiring of pump with solenoid relay switch	15
Setup mode	
Progressive-line system with reservoir monitoring, run and pause time only	16
Run mode	21
Running system (pump run)	21
Running system (pump pause)	21
Setup mode	
Progressive-line system with reservoir monitoring using run cycle counter	22
Run mode	27
Running system (pump run)	27
Running system (pump pause)	27
Wiring of pump with progressive-line system with sensors	28
Fault indications	29
Warranty	32

Description

Lubrication controller 85307 is a universal electronic control unit compatible with dual-line, single-line and progressive lubrication systems. Provides flexibility and control over traditional single-line systems. Controller digital display quickly identifies system status with easy-to-identify codes. Programming of unit requires simple information allowing operator to focus on specific utilized system.

Features





- Runs progressive, single-line and dual-line lubrication systems.
- Timing intervals from 5 seconds to 24 hours.
- Cycle counting.
- 10 V  to 30 V  operation.
- Short circuit/open circuit detection with audible warning.
- External fault lamp drive (flash or steady output).
- Low level reservoir monitoring.
- Two sensor switch inputs.
- Visual and audible fault indication.
- Non-volatile memory.
- Built-in blown fuse indicator.
- 3-digit LED display indicates exact system status.
- Simple setup procedure.
- Test mode allows testing of all circuits connected to controller.
- Practical housing with mounting bracket.

Table 1

Specifications	
Voltage	10 V  to 30 V 
Current drain	150 mA maximum (no load), 70 mA nominal
Pump output	7 A rms. maximum
Lamp output	3 A maximum
Switching	Solid state short circuit protected
Fuse	8 A fast blow 0.79 in (20 mm) glass
Connection	14 way MOLEX MINIFIT - JR
Communications	RS232 type
Dimensions	2.8 x 5.7 x 1.5 in (70 x 145 x 38 mm) ¹⁾
Weight	0.66 lbs (300 g)
Protection	IP54
Temperature range	5 °F to 122 °F (-15 °C to +50 °C)

¹⁾ Includes mounting bracket.

Safety

Read and carefully observe operating instructions before unpacking and operating equipment. Equipment must be operated, maintained and repaired exclusively by persons familiar with operating instructions. Local safety regulations regarding installation, operation and maintenance must be followed.

Operate equipment only after safety instructions and this service manual are fully understood.

Operational precautions

User must have total understanding of controller specifications. Never connect any other voltage supply other than specified in manuals contained within.

Operator/owner must ensure installation or inspections are executed by authorized personnel who have thoroughly read operating instruction manual.

Switch machine off before performing any setup or work on controller. Position machine so no harm can be caused to any person should machine be switched on during setup of controller. Operator or personnel working on machine must be advised in the event machine needs to be on for setup of controller.

Never switch machine on without prior knowledge of operator/owner or someone with full knowledge of machines operation.

Explanation of signal words for safety

NOTE

Emphasizes useful hints and recommendations as well as information to prevent property damage and ensure efficient trouble-free operation.

CAUTION

Indicates a dangerous situation that can lead to light personal injury if precautionary measures are ignored.

WARNING

Indicates a dangerous situation that could lead to death or serious injury if precautionary measures are ignored.

DANGER

Indicates a dangerous situation that will lead to death or serious injury if precautionary measures are ignored.

WARNING

- Never weld on machine while main switch of machine is on. Ensure main switch is off and correctly tagged. Welding on machine can cause serious damage to controller.
- Do not alter or modify any part of controller.
- Always mount controller in suitable area.
- Do not mount controller near an area with excessive heat.
- Always use correct specified fuse rating for controller.
- Never exceed voltage rating of controller.
- Never expose controller to direct sunlight.
- Never expose controller to water or other substances.

Keypad layout

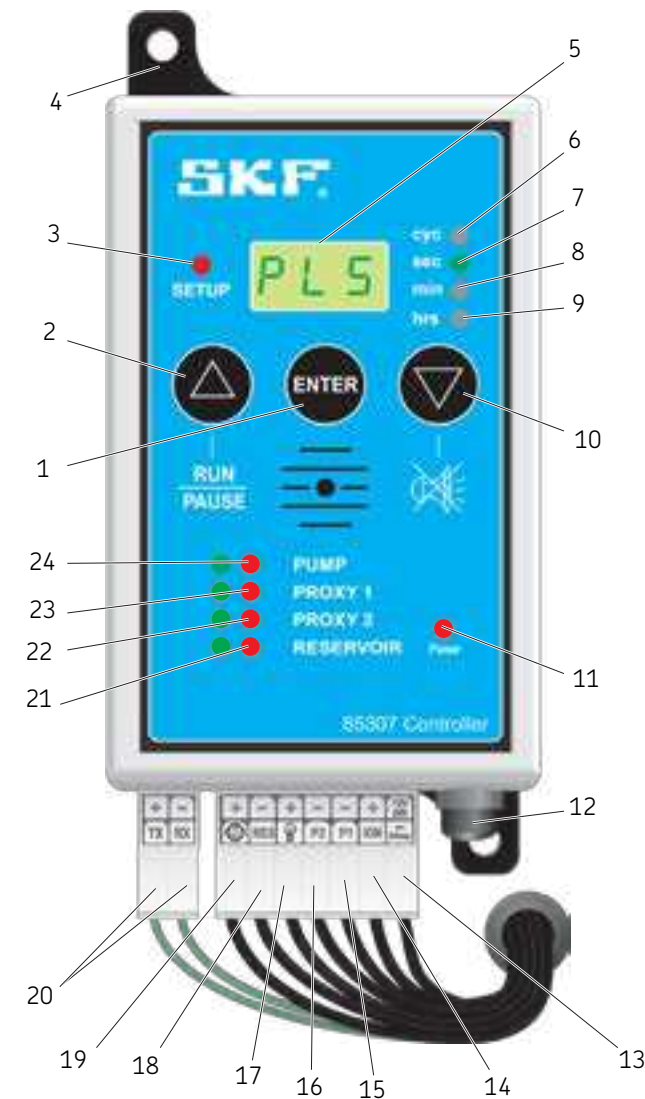

Item	Description
1	Enter button
2	Run/pause button
3	Setup indicator
4	Mounting bracket
5	LED display
6	Cycle indicator
7	Second indicator
8	Minute indicator
9	Hour indicator
10	Select value down or silent buzzer
11	Blown fuse indicator
12	Fuse holder, 8 A
13	Power positive/negative
14	Ignition input/aux power output positive
15	Sensor 1 positive/negative
16	Sensor 2 positive/negative
17	External lamp
18	Reservoir sensor connection
19	Pump motor positive/negative
20	RS 232 connection
21	Reservoir low level status indicator
22	Sensor 2 status indicator
23	Sensor 1 status indicator
24	Pump status indicator

Fig. 1

LED code descriptions



Fig. 2 SLS = single-line system

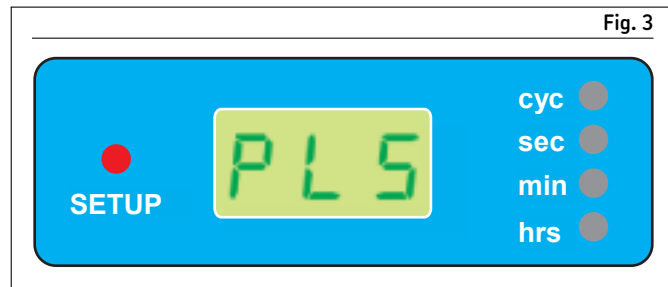

Fig. 3 PLS = progressive-line system



Fig. 4 DLS = dual-line system

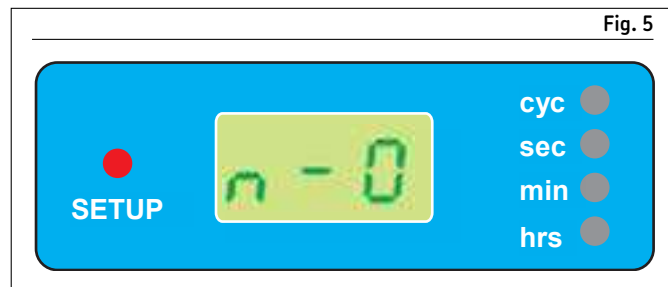

Fig. 5 n - 0 = normally open (sensors)

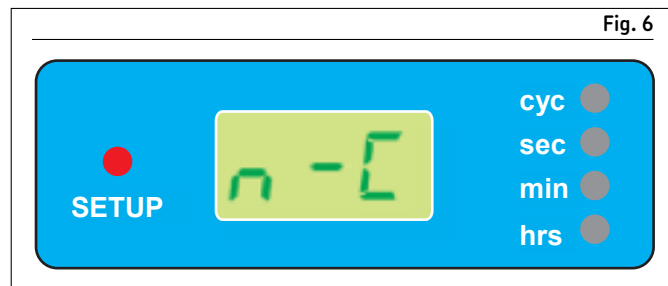

Fig. 6 n - C = normally closed (sensors)

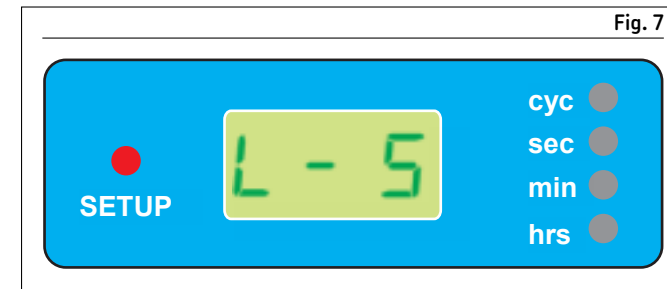

Fig. 7 L - S = external lamp steady (continued supply)

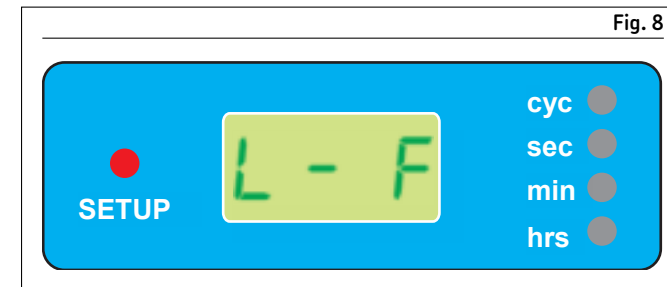

Fig. 8 L - F = external lamp flashing (pulsed supply)

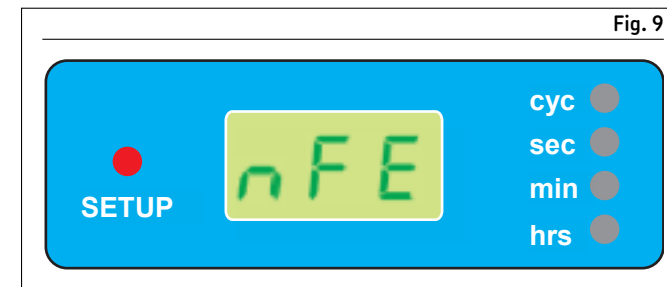

Fig. 9 nFE = non-fatal error (pump continues on low level fault)

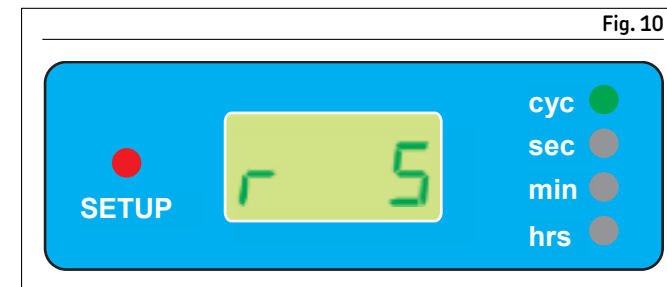

Fig. 10 r = run time in cycles

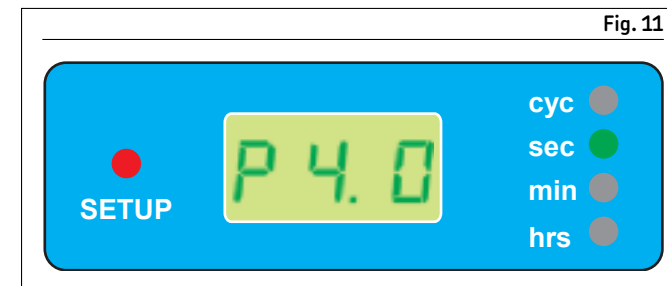

Fig. 11 P = pause time in seconds, minutes or hours

LED code descriptions



F = fault time in seconds, minutes or hours



U = vent time in seconds, minutes or hours

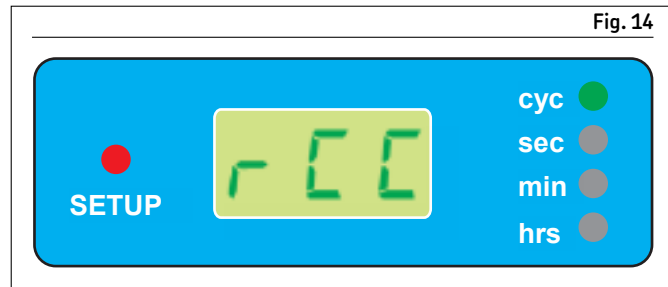

rCC = run cycle counter

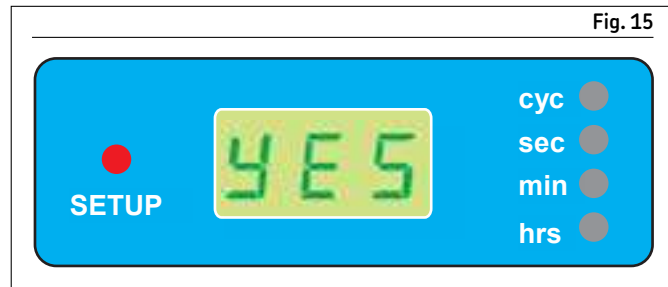

YES = confirms program changes

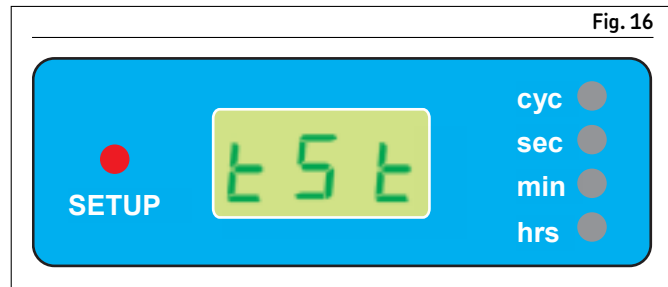

tSt = test mode for checking installed devices

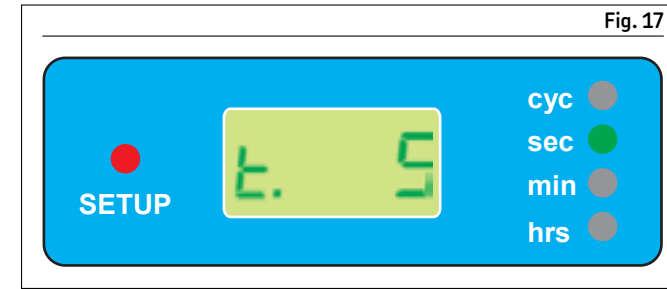

t = time out or dwell time for sensors

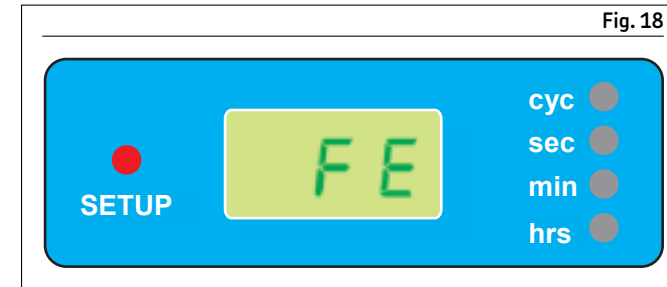

FE = fatal errors (pump stops on Low Level Fault)



n0 = do not select selection

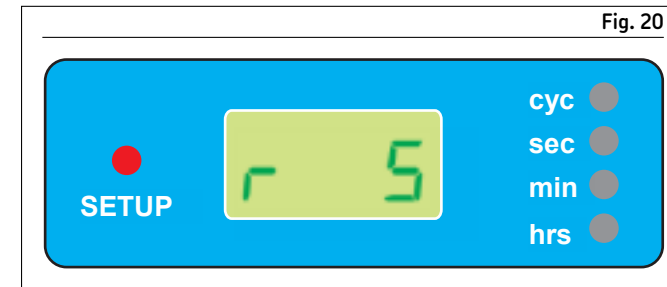

r = run time in seconds, minutes or hours

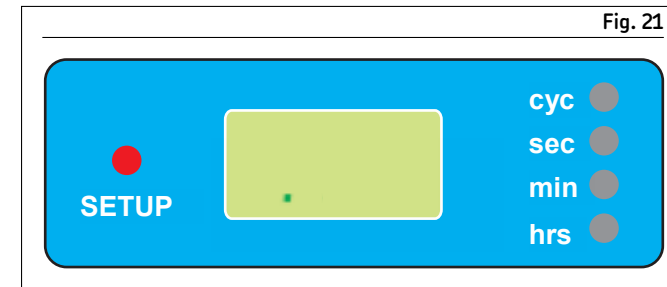

. = standby mode

Setup mode

Progressive-line system with no monitoring



Fig. 22



Fig. 23

- 1 To enter setup mode:
Press and hold **ENTER** while switching on controller power source.
- 2 Release **ENTER** and red LED next to **SETUP** illuminates. Green LED next to **PUMP** flashes. **PLS** (progressive-line system) appears in display.
- 3 Press **ENTER** to confirm use of progressive-line system (Fig. 22 A).

- 4 **P** (pause) appears in display. Press **Δ** to change time (Fig. 22 B). LED changes from seconds to minutes to hours. Display indicates amount of pause time when function is applied.
- 5 Press **ENTER** to confirm pause time. In example, pause time of 4 hours is confirmed (Fig. 22 C).

- 6 **R** (run) appears in display. Press **Δ** to change time (Fig. 23 A). LED changes from seconds to minutes to hours. Display indicates amount of run time.

- 7 Press **ENTER** to confirm run time. In example, run time of 30 minutes is confirmed (Fig. 23 B).

Fig. 24



A

B

C

- 8 With run time confirmed, select **Δ** or **∇** to verify sensor use (Fig. 24 A). Press **Δ** or **∇** until **n0** appears in display. Green LED flashes next to **PROXY 1** indicating sensor part of setup procedure.
- 9 Press **ENTER** to select **n0** and **PROXY 1** will not be setup (Fig. 24 B).

- 10 Press **ENTER** again on setup procedure to omit **PROXY 2** and green LED on **RESERVOIR** begins to flash.
- 11 Push **ENTER** to confirm **n0** for low level monitoring (Fig. 24 C).

Fig. 25



A

B

- 12 **L - F** (lamp flashing) displays. This option is used with external warning lamp. Typically, if monitoring is installed, this function is used. Press **Δ** and change status from **L - F** (lamp flashing) to **L - S** (lamp static). **L - F** is a pulsed output supply and **L - S** is a constant output supply.
- 13 With no monitoring used, press **ENTER** with either choice selected to move to next part of programming (Fig. 25 A).

- 14 **tSt** (test mode) appears in display indicating test mode of setup procedure. Press **Δ** for pump to start turning (Fig. 25 B). Correct pump from turning in wrong direction by changing polarity of wiring.
- 15 If all is correct, turn off power supply to controller.

NOTE

tSt must appear on display before switching off power to unit. System does not save changes if power to unit is turned off during any part of programming. **tSt** must appear on display for changes to be confirmed.

Fig. 26



Running system (pump run)

Run (r) time displays when controller is switched on. Time appears from actual time set and counts down to zero. Green LED indicates minutes (Fig. 26). Green LED next to PUMP flashes to indicate pump is turning or pumping.

Fig. 27



Running system (pump pause)

Controller enters pause time when required run time is reached. Pause (P) time counts down from original setup time to zero and then resumes run time (Fig. 27). Green LED is steady next to PUMP indicating pump is on but not turning while in pause mode.

Diagram 1

Wiring diagram of progressive-line system without sensors

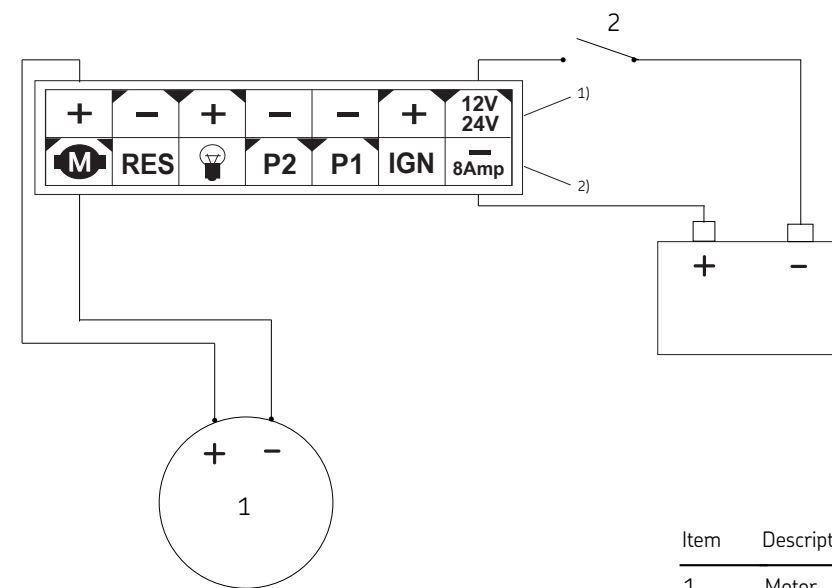

Item	Description
1	Motor
2	Ignition

1) Top row represents front of controller.
 2) Bottom row represents back of controller.
 NOTE: If motor amp draw exceeds the maximum specification (→ Table 1, page 3), solenoid relay switch (698975) must be used. Refer to (→ Diagram 2).

Diagram 2

Wiring of pump with solenoid relay switch

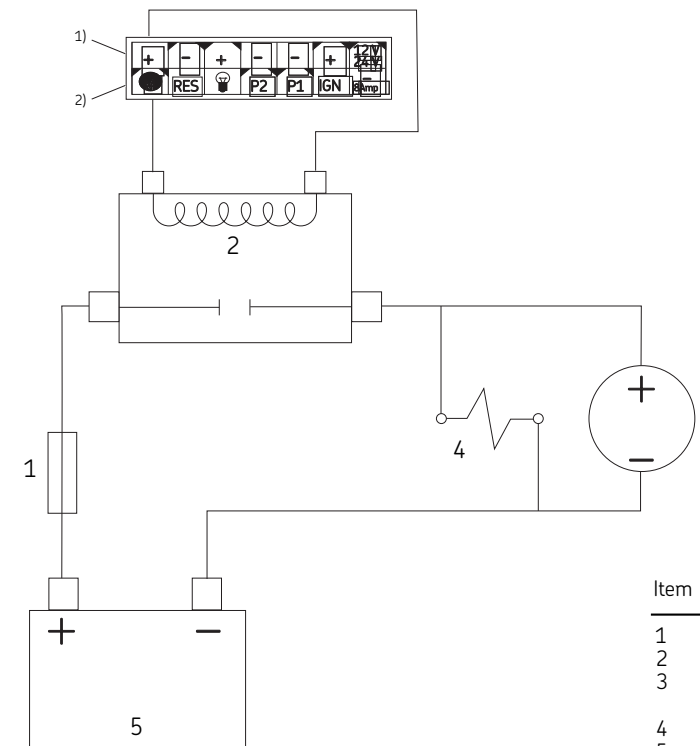

Item	Description
1	Fuse, 7.5 A
2	Solenoid relay switch
3	Motor
4	Vent valve solenoid (NO)
5	Power supply, 12 or 24 V

1) Top row represents front of controller.
 2) Bottom row represents back of controller.

Setup mode

Progressive-line system with reservoir monitoring, run and pause time only



Fig. 28



Fig. 29

- 1 Refer to **steps 1-6** on **pages 10** through **11**.
- 2 Select **Δ** or **∇** until **YES** appears in display to verify use of sensor (**Fig. 28 A**). Green LED flashes next to **PROXY 1** indicating sensor part of setup procedure.
- 3 Press **ENTER** to select **YES** and **PROXY 1** enters setup procedure.

- 4 **t** (time out) appears in display indicating alarm will activate if sensor does not send signal to controller within set time. This function is used when flow proximity sensor is installed on feeder. Within feeder, piston activates sensor and sends signal to controller. Controller resets time out and starts counting down to start monitoring process. This function continues to work while in **RUN** mode. Set time out greater than cycle time of specific feeder. This depends on type of pump being used. Press **Δ** to increase time out to desired setting.
- 5 Press **ENTER** to confirm. In example, time out of 5 seconds is confirmed (**Fig. 28 B**).

- 6 **n-0** (normally open) appears in display. Indicates if sensor is normally open or normally closed.
- 7 Press **Δ** to choose between **n-0** or **n-C**.
- 8 Press **ENTER** to confirm choice (**Fig. 29 A**).

- 9 **n0** appears in display. Green LED on **PROXY 2** illuminates. If 2nd proxy is necessary, proceed by pushing **Δ**.
- 10 Press **ENTER** to confirm and proceed setup for **PROXY 1**.
- 11 For one sensor, press **Δ** until **n0** appears in display.
- 12 Press **ENTER** to confirm (**Fig. 29 B**).

Fig. 30



13 **n0** appears in display. Green LED on reservoir illuminates (Fig. 30 A). In setup procedure, there is an option of selecting low level detection. If low level detection is not required, push **Δ** and select **n0**.

14 Press **ENTER** to confirm.

15 For this example, press **Δ** until **YES** appears in display.

16 Press **ENTER** to confirm (Fig. 30 B).

17 **n-0** (normally open) appears in display. This indicates sensor is normally open or normally closed. Press **Δ** to choose between **n-0** or **n-C**.

18 Press **ENTER** to confirm choice (Fig. 30 C).

NOTE

10-second delay occurs on startup when using low level sensor to ensure paddle assembly is in correct position.

Sensor activates on low level after 10 seconds. Low level warning displays when unit reaches pause status.

Fig. 31



19 **FE** (fatal error) or **nFE** (nonfatal error) appears in display. Option **FE** (fatal error) is used to stop pump on low level warning. Typically used on pumps with reservoir capacities from 0.26 to 2.6 gal (1 to 10 l). It is preferred to stop pump at low level to maintain layer of grease above pump element area thereby not allowing air pockets to form around pump element when filling up reservoir. Option **nFE** (nonfatal error) is recommended on larger pump reservoirs with substantial distance from pump tube to bottom of reservoir.

20 Select choice and press **ENTER** (Fig. 31 A).

21 **L - F** (lamp flashing) displays. This option is used with external warning lamp. Typically, if monitoring is installed, this function is used. Press **Δ** and change status from **L - F** (lamp flashing) to **L - S** (lamp static). **L - F** is a pulsed output supply and **L - S** is a constant output supply.

22 Press **ENTER** with either choice selected to proceed to next part of programming (Fig. 31 B).

Fig. 32



23 **tSt** (test mode) appears in display. Press **Δ** for pump to start turning (Fig. 32). Correct pump from turning in wrong direction by changing polarity of wiring. Check other sensors by energizing them manually and observing if green LED illuminates. If LED does not illuminate, a problem exists with wiring or setup procedure.

24 If all is correct, turn off power supply to controller

NOTE

tSt must appear on display before switching off power to unit. System does not save changes if power to unit is turned off during any part of programming. **tSt** must appear on display for changes to be confirmed.

Fig. 33



Run mode

Unit proceeds in run (r) mode after power is terminated on unit and then switched on again. All devices selected display.

Fig. 34



Running system (pump run)

Run (r) time displays when controller is switched on. Time appears from actual time set and counts down to zero. Green LED indicates minutes (Fig. 34). Green LED next to **PUMP** flashes to indicate pump is turning or pumping.

Fig. 35



Running system (pump pause)

Controller goes into pause time when required run time is reached. Pause (P) time counts down from original setup time to zero and then resumes run time (Fig. 35). Green LED next to **PUMP** is steady to indicate pump is there by not turning while in pause mode.

Setup mode

Progressive-line system with reservoir monitoring using run cycle counter



Fig. 36



Fig. 37

1 Refer to **steps 1–5 on pages 10**.

2 To use **rCC** (run cycle counter), select **∇** (Fig. 36 A).

If **Δ** is pressed by accident, continue to press **Δ** until **rCC** displays.

During run cycle, controller looks for signal from proximity sensor normally fitted to feeder system ensuring complete machine is lubricated adequately.

Some calculation is necessary to calculate cycles required through specific feeder system used.

3 **t** (time out) appears in display indicating alarm will activate if sensor does not send signal to controller within set time. This function is used when flow proximity sensor is installed on feeder. Piston activates sensor within feeder and sends signal to controller. Controller resets time out and starts counting down to start monitoring process. This function continues to work while in run cycle mode. It is important to set time out greater than cycle time of specific feeder. This also depends on pump being used. Press **Δ** to increase time out to desired setting.

4 Press **ENTER** to confirm (Fig. 36 B).

In example, time out of 45 seconds is confirmed.

5 **n-0** (normally open) appears in display. This indicates if sensor is normally open or normally closed. Press **Δ** to choose between **n-0** or **n-C**.

6 Press **ENTER** to confirm choice (Fig. 37 A).

7 Press **ENTER** again to confirm use of run cycle counter (Fig. 37 B).

8 Press **Δ** to increase number of cycles required (Fig. 37 C). Remember 1 cycle represents complete cycle of feeder.

For example, should 6 port feeder be used, 1 cycle indicates feeder has lubricated all 6 points. 1 cycle is not equal to 1 minute run time. The larger the feeder, the longer it takes to reach 1 cycle

9 After selecting amount of cycles, press **ENTER** to confirm.

Fig. 38



A

B

10 n0 appears in display. Green LED on PROXY 2 illuminates. Should 2nd proxy be necessary, proceed by pushing Δ.

11 Press ENTER to confirm and proceed setup for PROXY 1.

12 When one sensor is used, press Δ until n0 appears in display.

13 Press ENTER to confirm (Fig. 38 A).

14 n0 appears again in display. Green LED on RESERVOIR illuminates. Setup procedure allows selection of low level detection.

Push Δ and select n0 if low level detection is not required.

15 Press ENTER to confirm. For this example, select low level option by pressing Δ until YES appears in display.

16 Press ENTER to confirm (Fig. 38 B).

NOTE

10-second delay occurs on startup when using low level sensor to ensure paddle assembly is in correct position.

Sensor activates on low level after 10 seconds. Low level warning displays when unit reaches pause status.

Fig. 39



A

B

C

17 n-0 (normally open) displays indicating if sensor is normally open or normally closed. Press Δ to choose between n-0 or n-C.

18 Press ENTER to confirm choice (Fig. 39 A).

19 FE (fatal error) or nFE (nonfatal error) appears in display.

Option FE (fatal error) is used to stop pump on low level warning. Typically used on pumps with reservoir capacities from 0.26 to 2.6 gal (1 to 10 l). It is preferred to stop pump at low level to maintain layer of grease above pump element area thereby not allowing air pockets to form around pump element when filling up reservoir (Fig. 39 B).

Option nFE (nonfatal error) is recommended on larger pump reservoirs with substantial distance from pump tube to bottom of reservoir (Fig. 39 C).

20 Press Δ to select choice and press ENTER to confirm.

Fig. 40



A

B

C

21 **L - F** (lamp flashing) displays (Fig. 40 A). This option is used with external warning lamp, typically used if monitoring is installed. Press **Δ** and change status from **L - F** (lamp flashing) to **L - S** (lamp static) (Fig. 40 B). **L - F** is a pulsed output supply and **L - S** is a constant output supply.

22 Select option and press **ENTER** to proceed to next part of programming.

23 **tSt** (test mode) appears in display. Pump starts turning. Correct pump from turning in wrong direction by changing polarity of wiring. Check other sensors by energizing them manually and observing if green LED illuminates. If LED does not illuminate, a problem exists with wiring or setup procedure.

24 If all is correct, turn off power supply to controller

NOTE

tSt must appear on display before switching off power to unit. System does not save changes if power to unit is turned off during any part of programming. **tSt** must appear on display for changes to be confirmed.

Fig. 41



Run mode

Unit proceeds in run (r) mode after power is terminated on unit and then switched on again. All devices selected display. After each cycle received, amount decreases by 1 until all cycles have been reached and unit proceeds to pause time.

Fig. 42



Running system (pump run)

When controller is switched on, run cycle counter (rCC) appears in display. Counter appears from actual counts set and counts down to zero. Green LED indicates run cycle counter. Green LED on **PUMP** flashes indicating pump is turning or pumping.

Fig. 43



Running system (pump pause)

Controller goes into pause time when required cycle count is reached. Pause (P) time counts down from original setup time to zero and then resumes cycle count. Green LED next to **PUMP** is steady to indicate pump is there by not turning while in pause mode.

Wiring of pump with progressive-line system with sensors

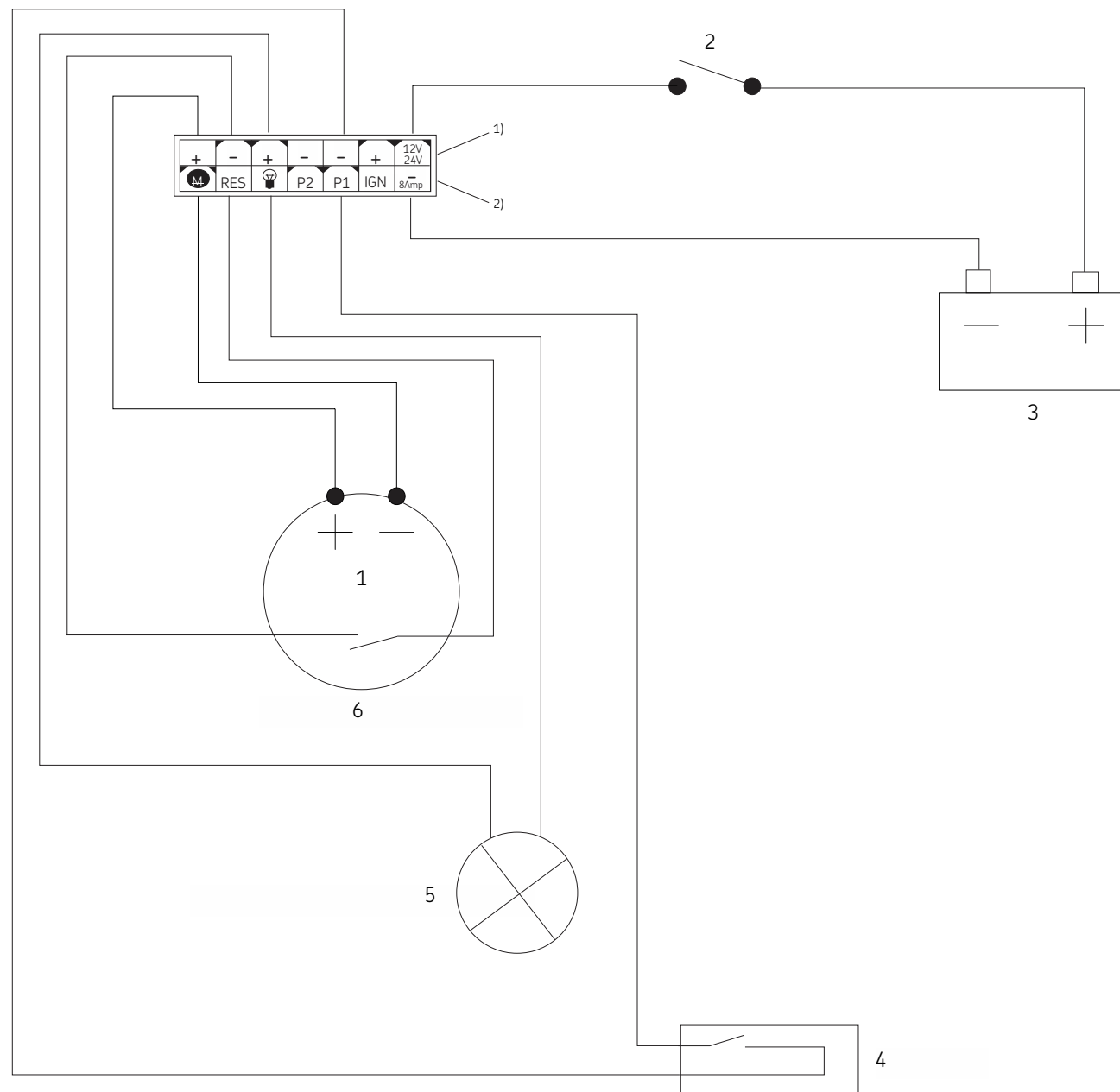

Item	Description
1	Motor
2	Power switch
3	Power supply
4	Proxy 1
5	External warning lamp
6	Low level sensor

1) Top row represents front of controller.
2) Bottom row represents back of controller.

Fault indications



Item	Description
1	Press RUN/PAUSE to reset faults.
2	Fault indication – counts up from seconds to minutes to hours indicating how long fault has been active. Press ▼ button to silence buzzer.
3	
4	Blown fuse indication – replace with 8A fuse.
5	Fuse holder – use 8 A fuse.
6	Low level fault – possible cause, reservoir empty.
7	PROXY 1 fault – either blockage in system or faulty sensor.
8	PUMP fault – either short circuit or wires are disconnected.

NOTE

Unit must perform one complete cycle of run and pause to cancel existing fault out of memory for fault to reset. Unit is designed to memorize total time of any specific fault. Unit must run one complete cycle to function correctly without same fault occurring.

This page left intentionally blank.

This page left intentionally blank.

Warranty

The instructions do not contain any information on the warranty.
This can be found in the General Conditions of Sales, available at:
www.lincolnindustrial.com/technicalservice or www.skf.com/lubrication.

skf.com | lincolnindustrial.com

© SKF and Lincoln are registered trademarks of the SKF Group.

© SKF Group 2020
The contents of this publication are the copyright of the publisher and may not be reproduced (even extracts) unless prior written permission is granted. Every care has been taken to ensure the accuracy of the information contained in this publication but no liability can be accepted for any loss or damage whether direct, indirect or consequential arising out of the use of the information contained herein.

August 2020 · Form 404771 Version 2