

Pressure-Reduction Valve NG 6 cartridge, directly controlled



- damped piston valve
- small hysteresis
- several pressure steps
- some adjustment method

Technical Data

General

Symbol	please see symbol diagram
Type of valve	piston valve, damped
Mounting	M24 x 1,5
Connection of port	location hole
Mounting positions	mountable in any positions
Ambient temperature	-5 to +50 °C
Mass valve	0.5 kg

Hydraulic

Operation pressure range	
Ports A, B	3 - 30; 5 - 60;
	10 - 150 or 20 - 250
Hydraulic oil temperature	-10 to +70 °C
Viscosity range	10 to 300 mm ² /s
Operating flow range	see characteristic curve

Symbol

D40

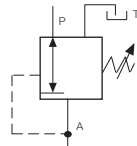

Characteristic curve

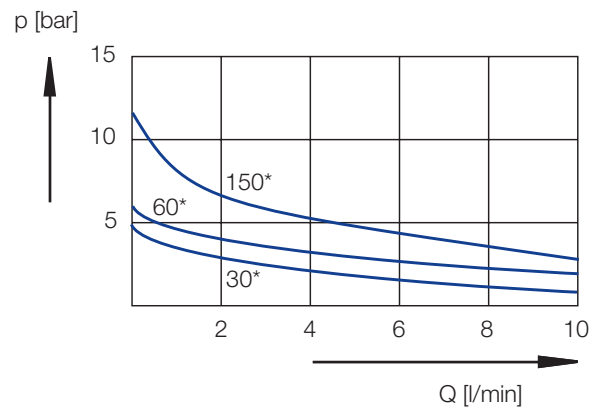
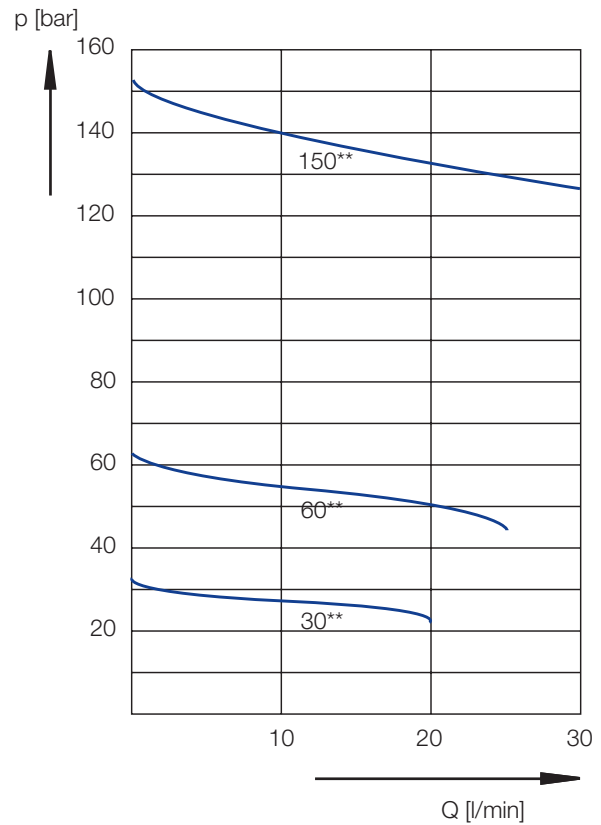

*min. adjustable pressure

**max. adjustable pressure

Dimensional Drawing

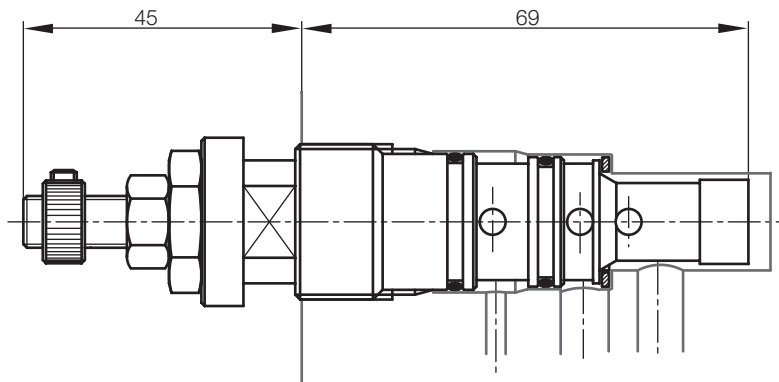

Adjustment Methods

design S
S = setting screw

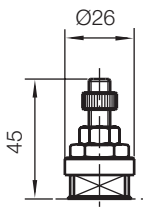

design K; P
K = cover
P = cover with lead seal

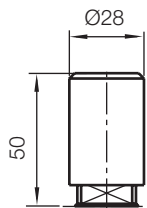

design G
G = star knob

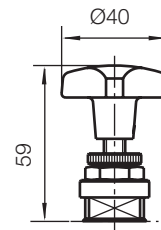

design H
H = handwheel

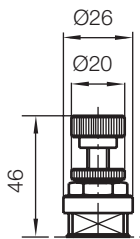

design D
D = rotary knob

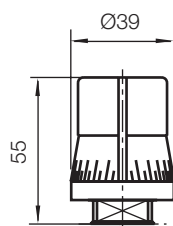

design V
V = rotary knob and lock

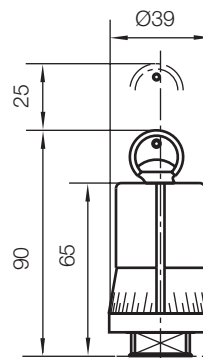

all dimensions in mm

Type Code

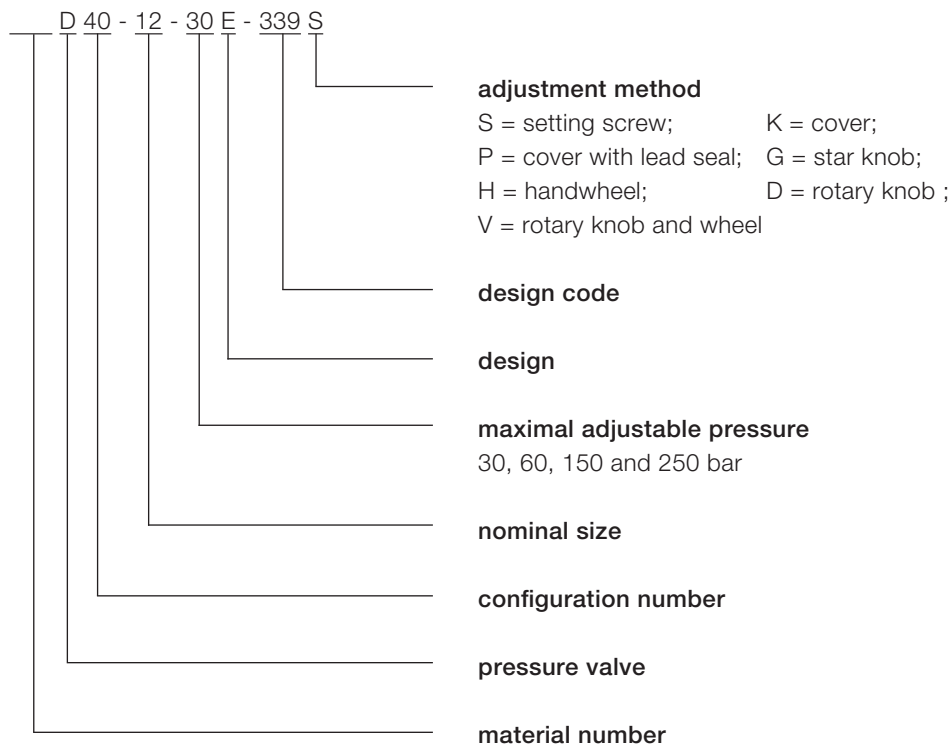

Voith Turbo H + L Hydraulic GmbH & Co. KG
Schuckertstraße 15
71277 Rutesheim, Germany
Tel. +49 7152 992-3
Fax +49 7152 992-400
sales-rut@voith.com

voith.com



VOITH
Engineered Reliability